

**12'x14'**  
**STEEL GAZEBO WITH**  
**NETTING**

**ASSEMBLY INSTRUCTIONS**

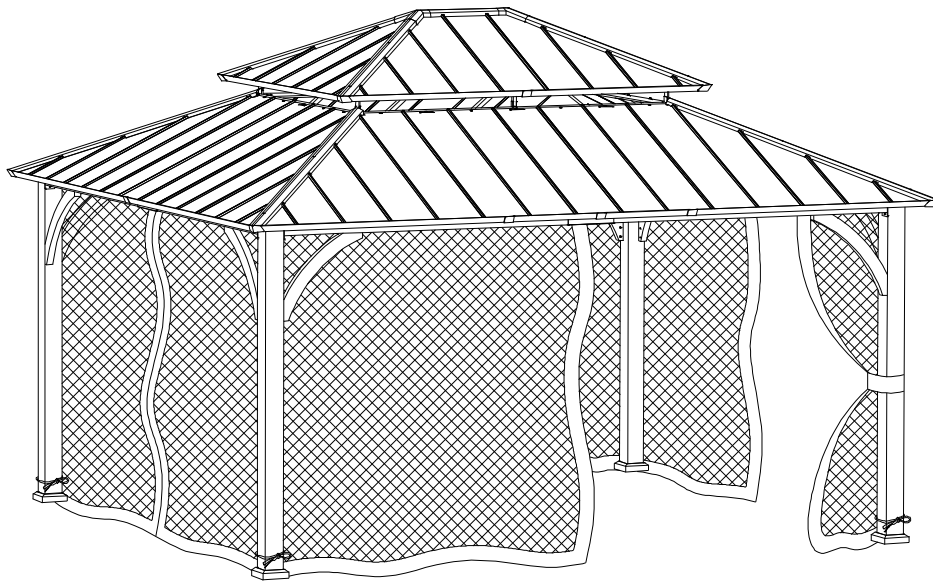

**Note: The gazebo needs to be installed in cooperation with four people.  
The following tools are not included and needed for assembly:**



Drill



Hammer



Ladder

**Questions? Issues? Missing Part? Professional Installation Service?  
Contact us at email [customer.care@sunjooygroup.com](mailto:customer.care@sunjooygroup.com)**

## Important Safety Instructions

**Warning!** To reduce the risk of serious injury, read the following safety instructions before assembling and using the gazebo.







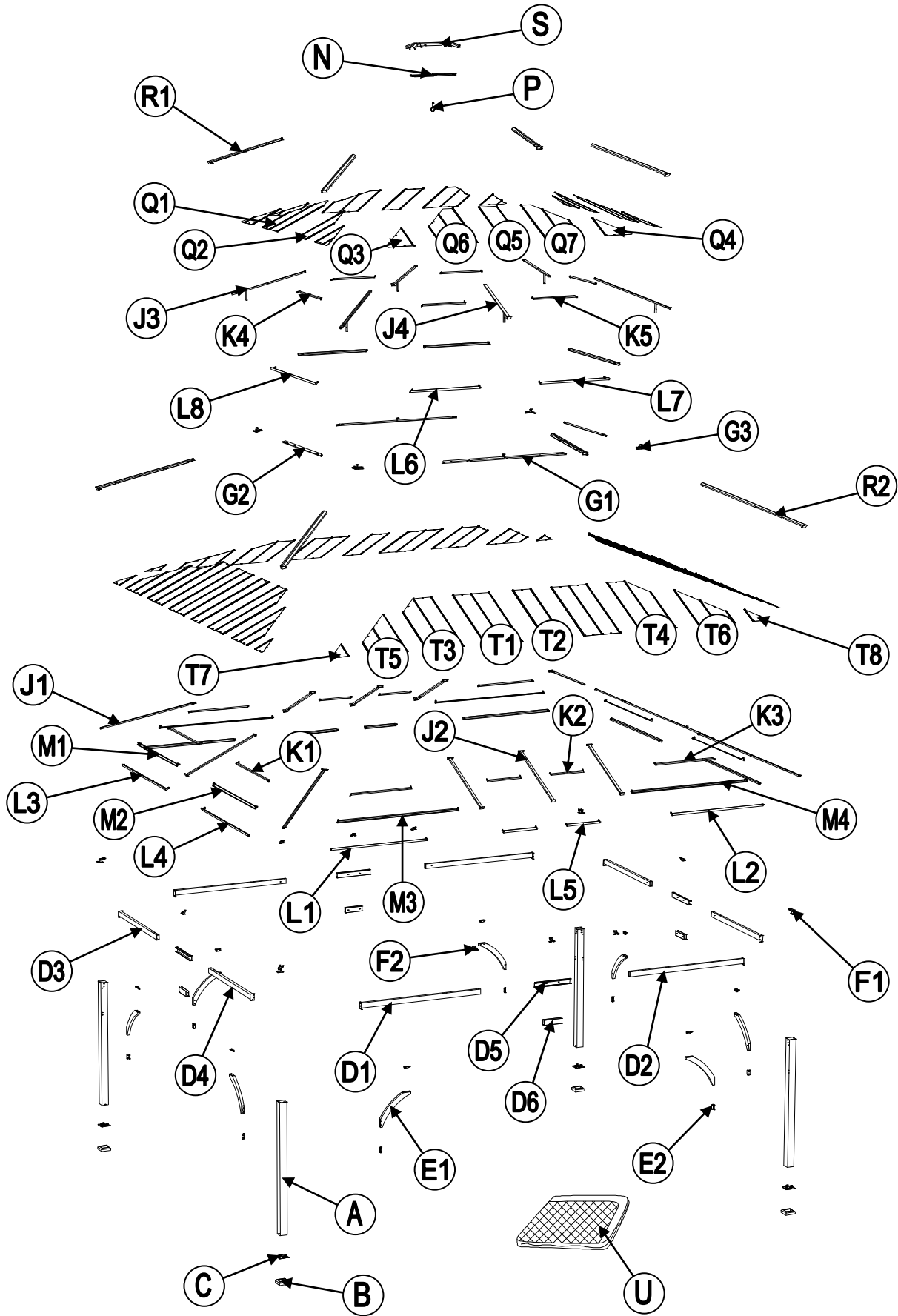





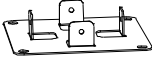



**Caution!** Always keep children under close supervision while they are using or around this product. Never leave children unattended.





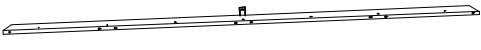

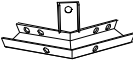











- This product is intended for outdoor use only.
- The product should be assembled on a flat stable surface.
- Do not assemble the gazebo on unstable surfaces.
- Ensure the location and clearance of your gazebo is acceptable.
- The gazebo must be anchored with stakes into the ground for added safety. It is recommended that it should not be permanently attached to a concrete floor or platform.
- Arrange the necessary manpower when assembling or moving the product.
- Some parts may contain sharp edges. Wear protective gloves and glasses if necessary.
- Keep children and pets away while setting up the gazebo.
- Check all nuts and bolts periodically for tightness. When required, tighten them again.
- Repairing and replacing parts should be done by a qualified technician.
- The gazebo is intended for decorative and shade purposes only, and is not designed to withstand harsh weather, including high winds, rain and snow.
- If the product is not being used for long periods of time (e.g. winter), it should be stored in a clean, dry environment.
- Do not put a Liquid Propane or Wood Burning fire pit or fireplace inside the product.
- Do not climb or place heavy objects onto the gazebo roof.
- Retain the original packaging to store and protect the gazebo during the winter months.
- Do not use or enter the gazebo if the following conditions exist:
  1. Visible movement of supports, roofing panels or a sagging roof.
  2. Unusual noise from the gazebo.
  3. Deformed roof panels.
  4. Damaged or missing bolts/fasteners.
- Please check your HOA, Local, and State Governments prior to purchasing and assembling gazebos. These local organizations may require permits and specific requirements for installation.
- Maintain your instruction manual for future reference.
- Warranty: Please retain your receipt for proof of purchase.











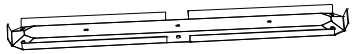

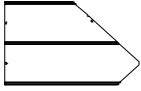
**EXPLODED DRAWING**



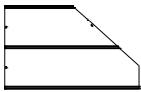

## Part List

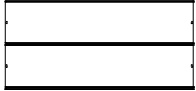

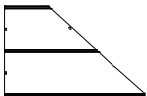
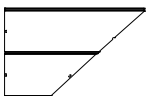

Description	Label	Part Number	Qty	Part Image
Post	A	P00020083001	4	
Base Cover	B	P00610026901	4	
Post Base	C	P00010026001	4	
Long Cross Beam 1	D1	P00040156301	2	
Long Cross Beam 2	D2	P00040156401	2	
Short Cross Beam 1	D3	P00040156101	2	
Short Cross Beam 2	D4	P00040156201	2	
Cross Beam Connector	D5	P00050197901	4	
Cross Beam Cap	D6	P00560054001	4	
Brace	E1	P00500078701	8	
Brace Connector	E2	P00050198001	16	
Rafter Connector	F1	P00050190102	4	
Middle Beam Connector	F2	P00050190004	8	
Big Roof Long Frame	G1	P00050189001	2	
Big Roof Short Beam	G2	P00050188802	2	
Big Roof Corner Connector	G3	P00050188404	4	
Big Roof Rafter	J1	P00060253904	4	
Big Roof Middle Beam	J2	P00060254103	8	

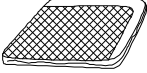
Small Roof Rafter	J3	P00060251302	4	
Small Roof Middle Beam	J4	P00060251702	2	
Small Beam (Short Side)	K1	P00060254701	4	
Short Small Beam (Long Side)	K2	P00060254901	4	
Long Small Beam (Long Side)	K3	P00060254601	4	
Small Roof Short Top Beam	K4	P00060252002	2	
Small Roof Long Top Beam	K5	P00060252102	4	
Short Left Panel Flashing	L1	P00060255604	2	
Short Right Panel Flashing	L2	P00060255704	2	
Long Left Panel Flashing	L3	P00060255803	2	
Long Right Panel Flashing	L4	P00060255903	2	
Big Roof Middle Panel Flashing (Long Side)	L5	P00060256201	4	
Small Roof Left Long Panel Flashing	L6	P00060253102	2	
Small Roof Right Long Panel Flashing	L7	P00060253202	2	
Small Roof Short Panel Flashing	L8	P00060252902	2	
Left Short Mosquito Netting	M1	P00570055603	2	
Right Short Mosquito Netting	M2	P00570055703	2	
Left Long Mosquito Netting	M3	P00570055801	2	
Right Long Mosquito Netting	M4	P00570055901	2	

Small Connector	N	P00050188103	1	
Hook	P	P00580015401	1	
Small Roof Left Big Panel (Short Side)	Q1	P00070119602	2	
Small Roof Right Big Panel (Short Side)	Q2	P00070119702	2	
Small Roof Left Small Panel	Q3	P00070120102	4	
Small Roof Right Small Panel	Q4	P00070120202	4	
Small Roof Middle Panel	Q5	P00070119802	2	
Small Roof Left Big Panel (Long Side)	Q6	P00070119902	2	
Small Roof Right Big Panel (Long Side)	Q7	P00070120002	2	
Small Roof Rafter Cap	R1	P00080043402	4	
Big Roof Rafter Cap	R2	P00080043803	4	
Small Roof Cap	S	P00090019002	1	
Big Roof Middle Panel	T1	P00070122602	6	
Big Roof Middle Small Panel	T2	P00070122702	4	
Big Roof Left Big Panel	T3	P00070122403	4	

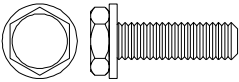
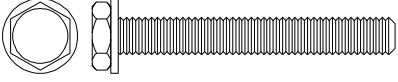
Big Roof Right Big Panel	T4	P00070122503	4	
Big Roof Left Middle Panel	T5	P00070122204	4	
Big Roof Right Middle Panel	T6	P00070122304	4	
Big Roof Left Small Panel	T7	P00070122004	4	
Big Roof Right Small Panel	T8	P00070122104	4	
Mosquito Netting	U	P00120028701	1	

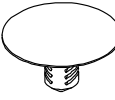
### Hardware Pack

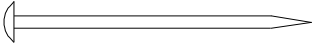
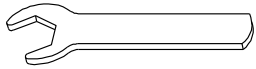
Label	Description	Part Number	Qty	Part Image
H1	Bolt M6*20	H100010047	418+21	
H2	Bolt M6*45	H100010059	16+1	
HH1	M6 Rubber Washer	H050050018	16+1	
HH2	Plastic Cap	H990010010	24+2	
HR	Ring	H990050001	60+3	
HS	Stake $\Phi 8*180$	H070010003	8	
HW	Wrench M6	H090010017	2	

# 1

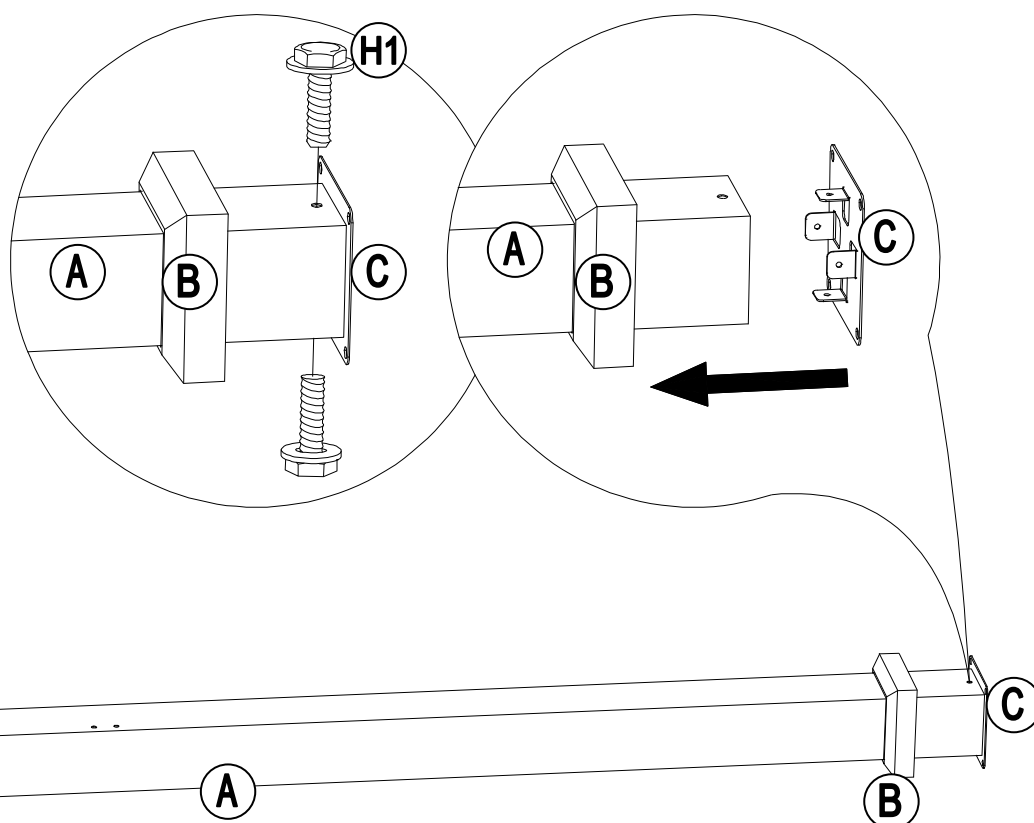
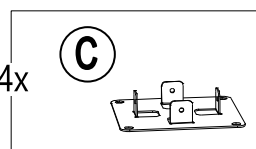
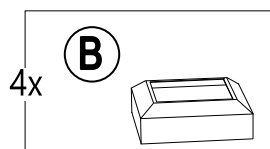
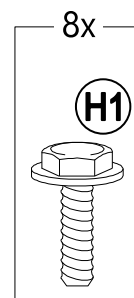
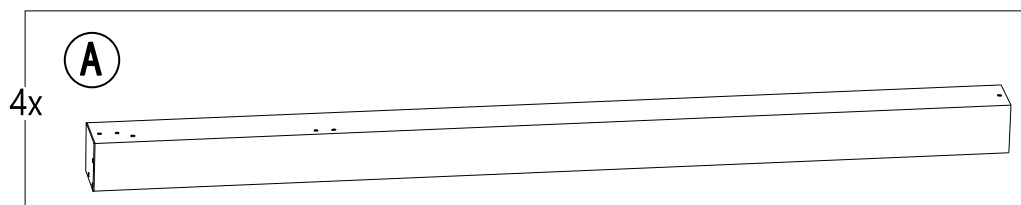



# 2

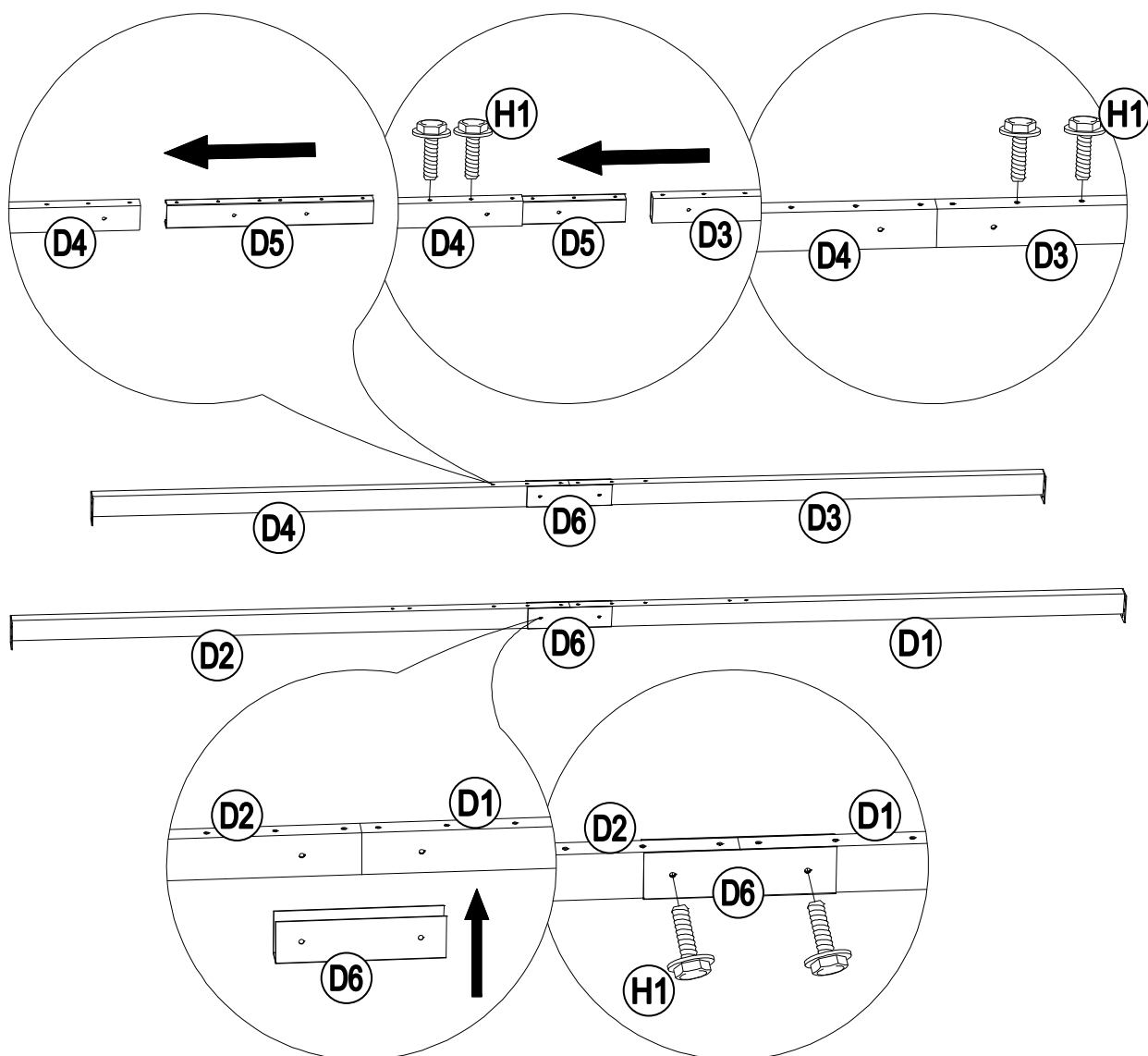
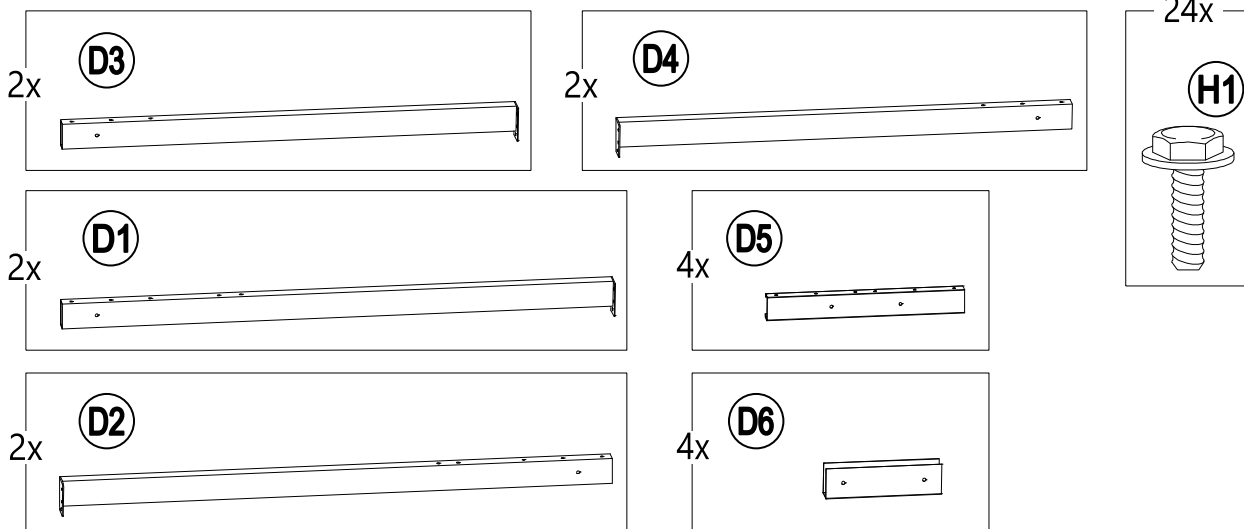

3

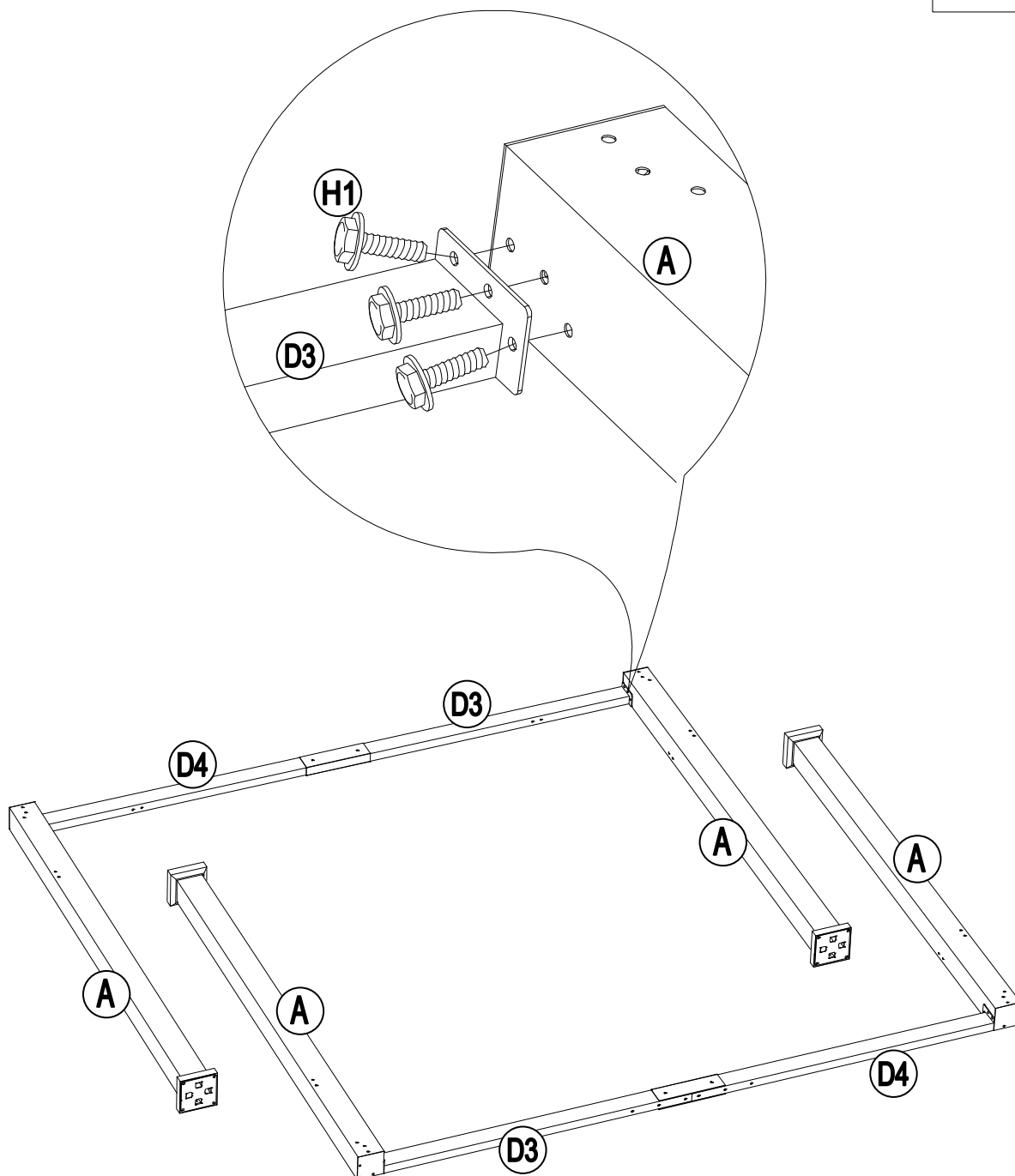
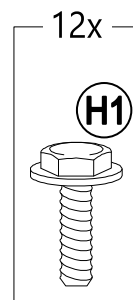

4

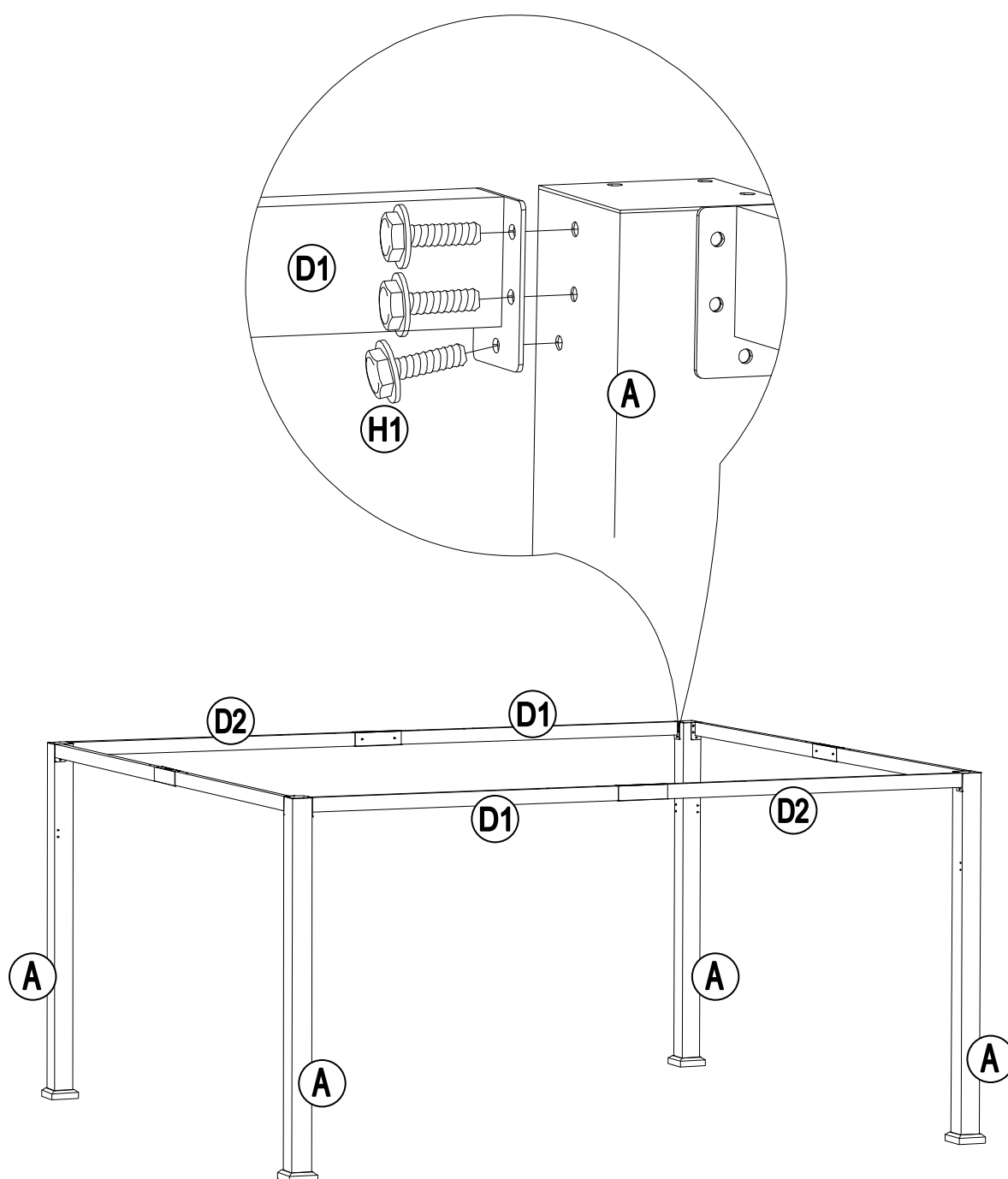
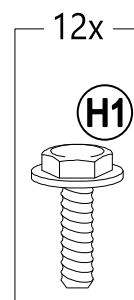

# 5

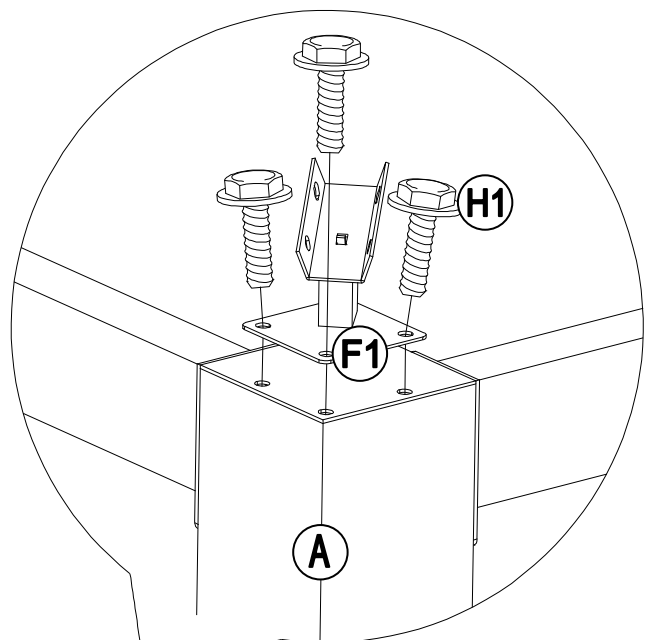
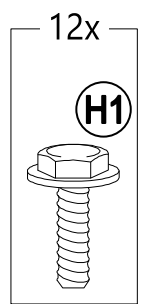
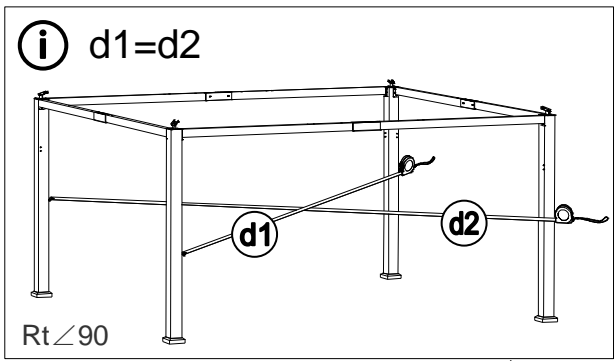
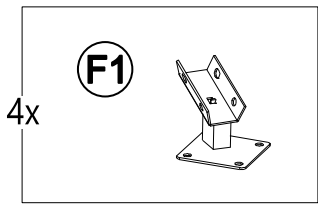

Make sure the distances in between the diagonal poles d1 and d2 are the same.

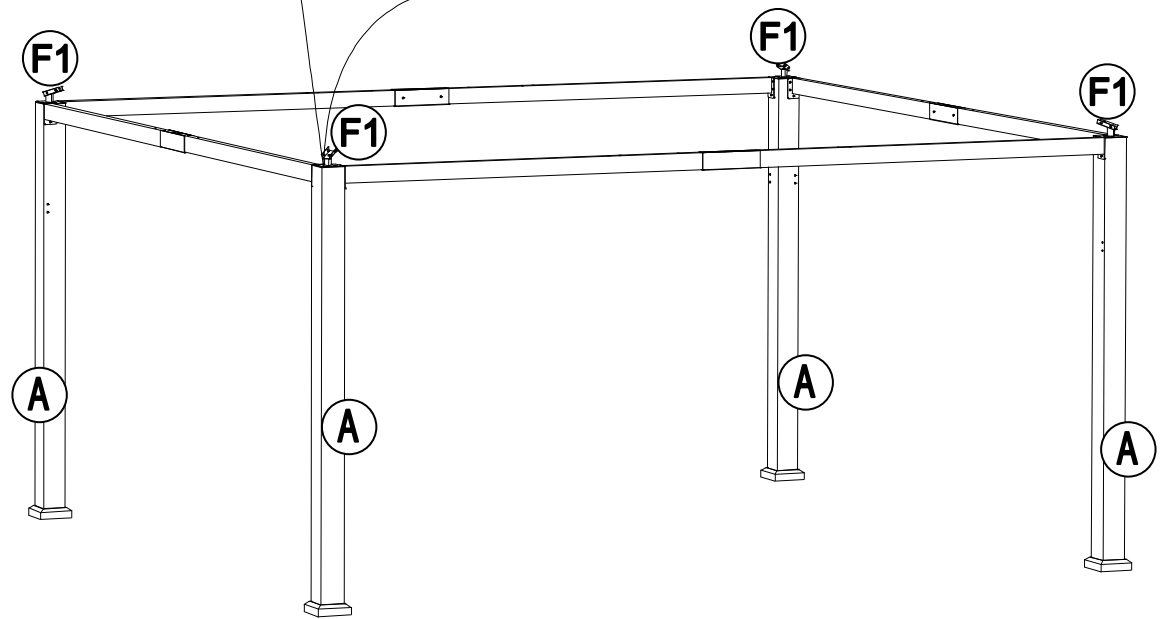

6

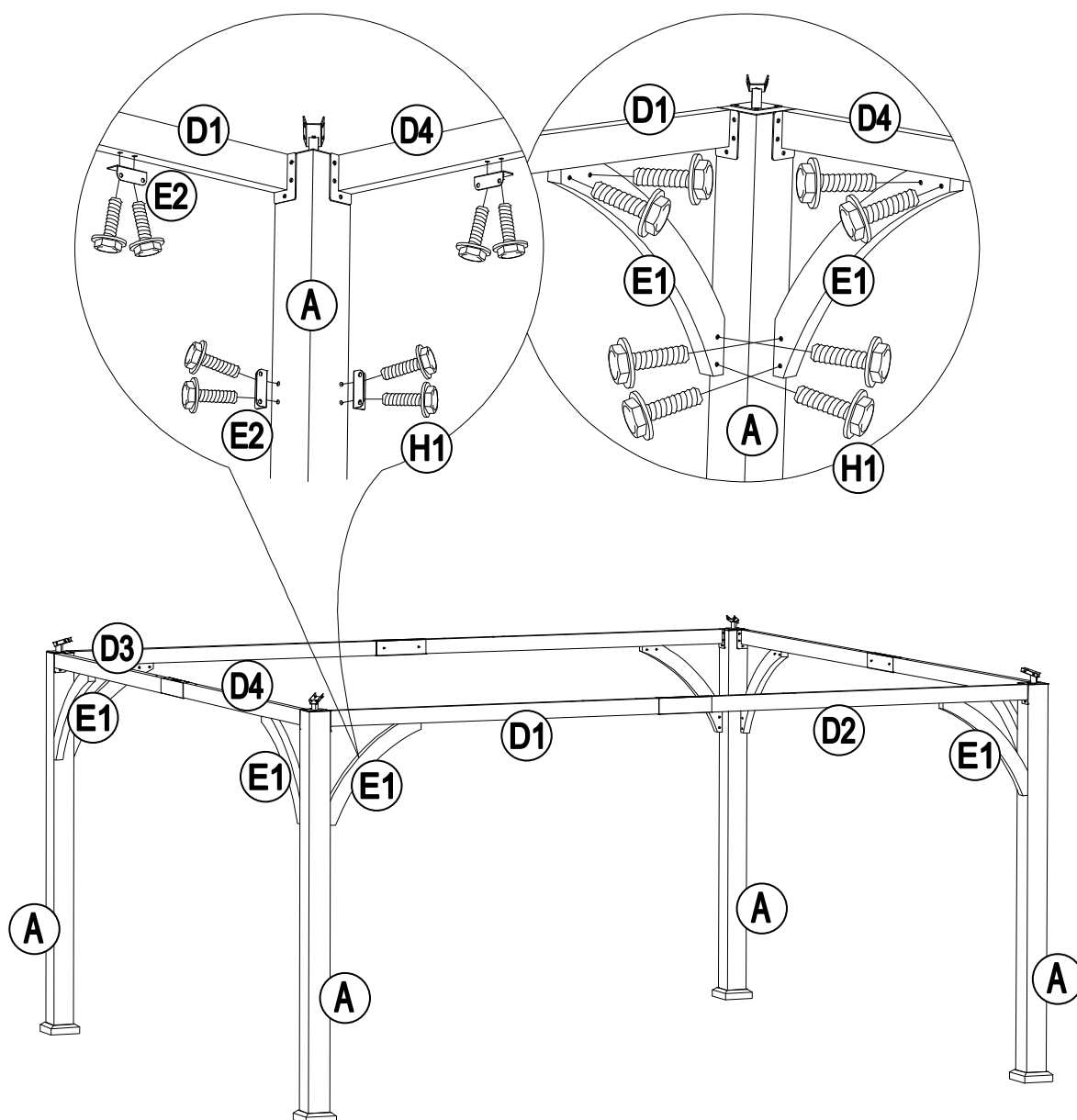
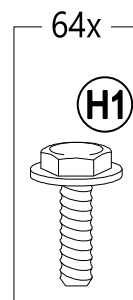
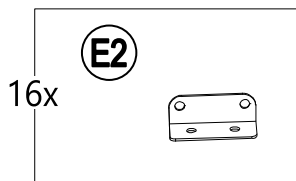
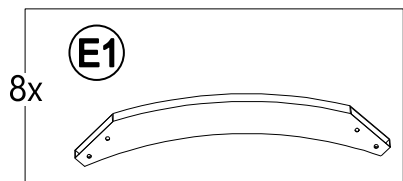

7

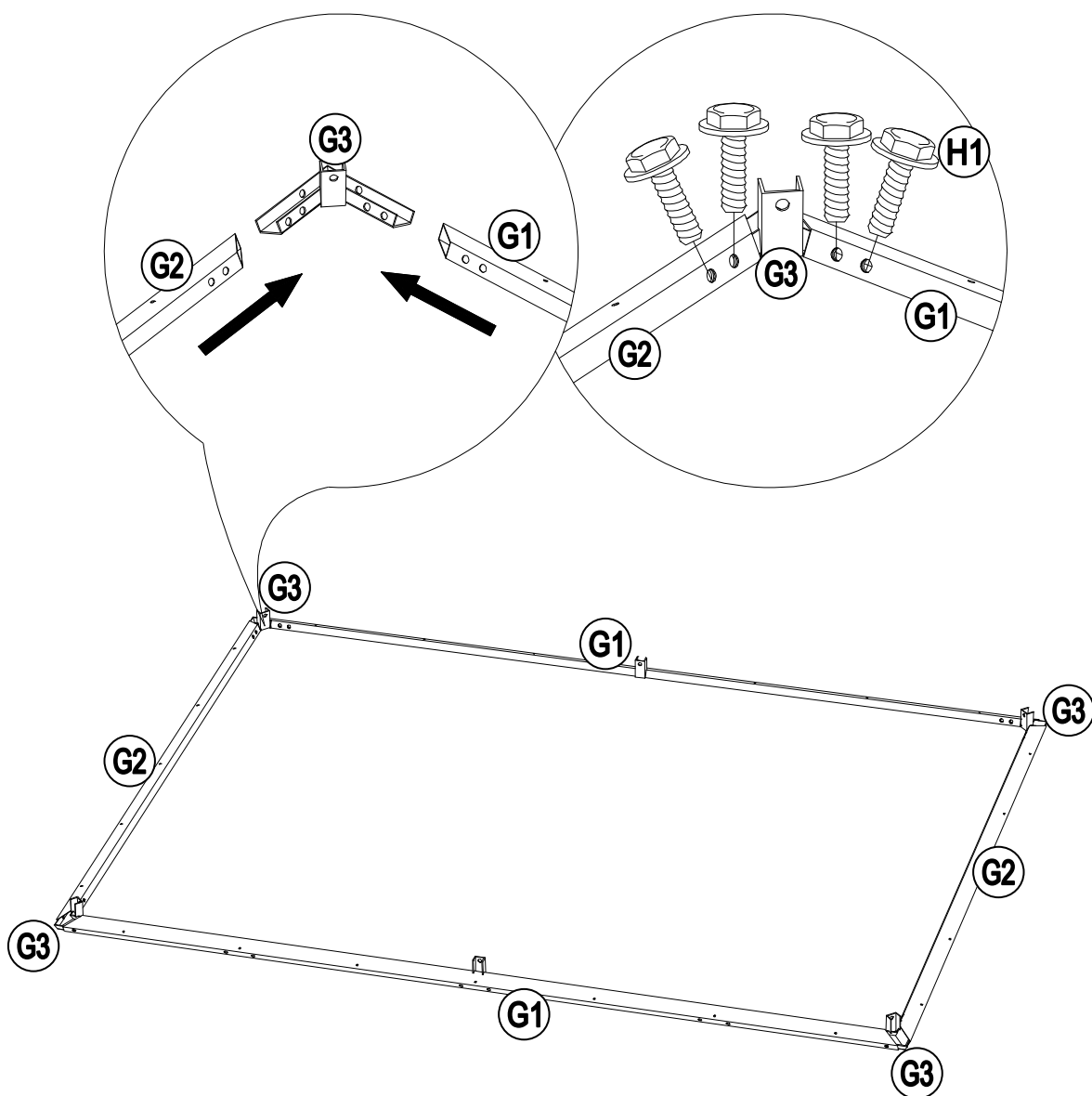
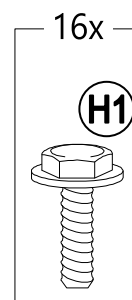
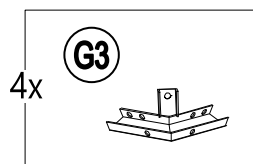
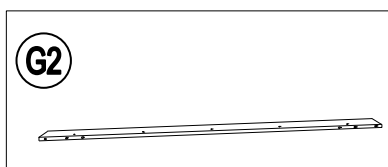
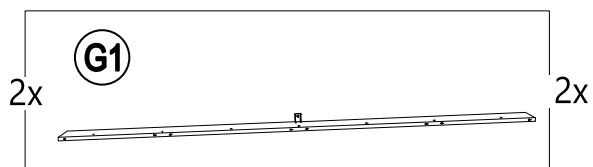

# 8

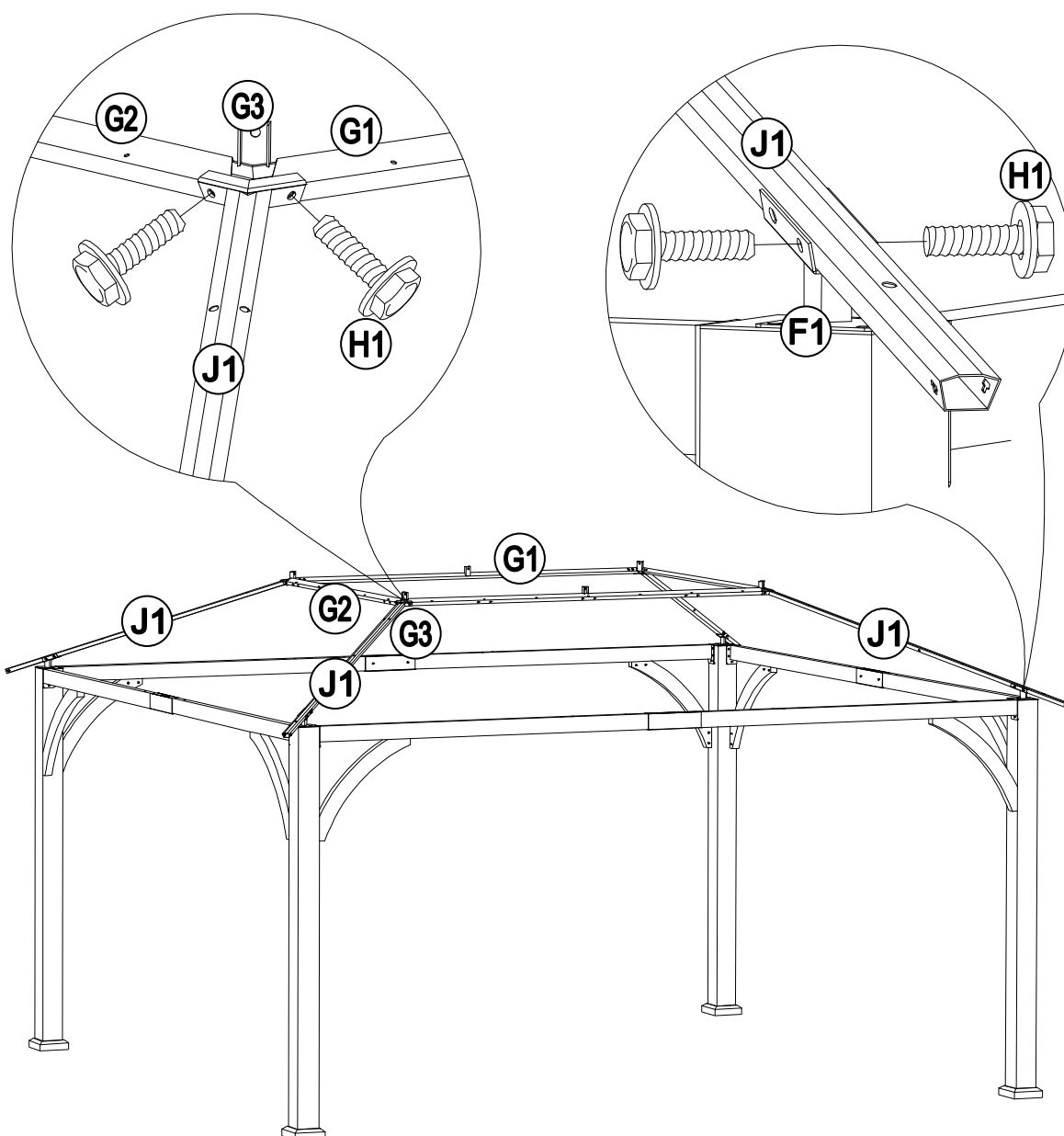
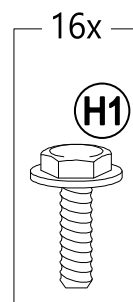
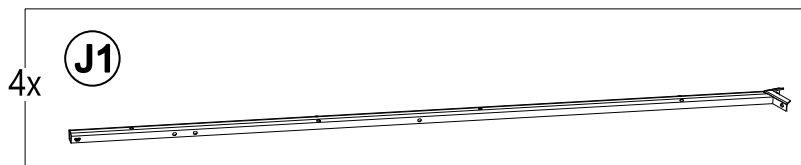

# 9

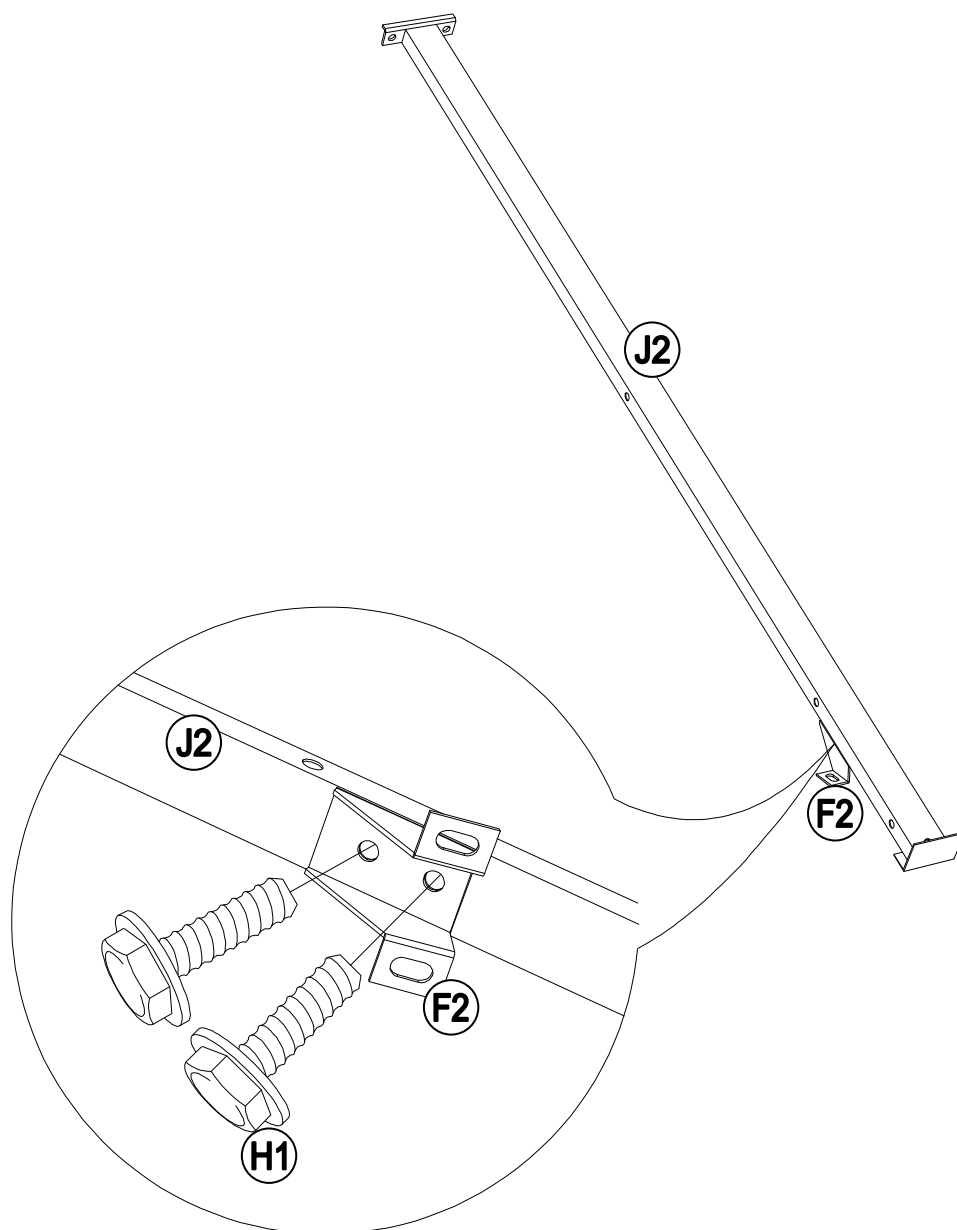
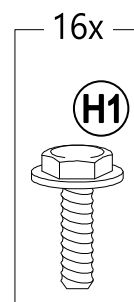
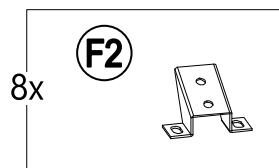
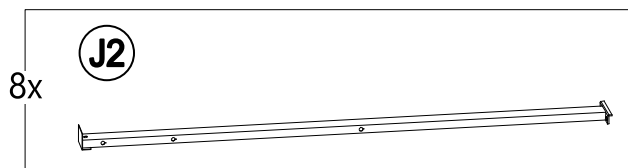



# 10

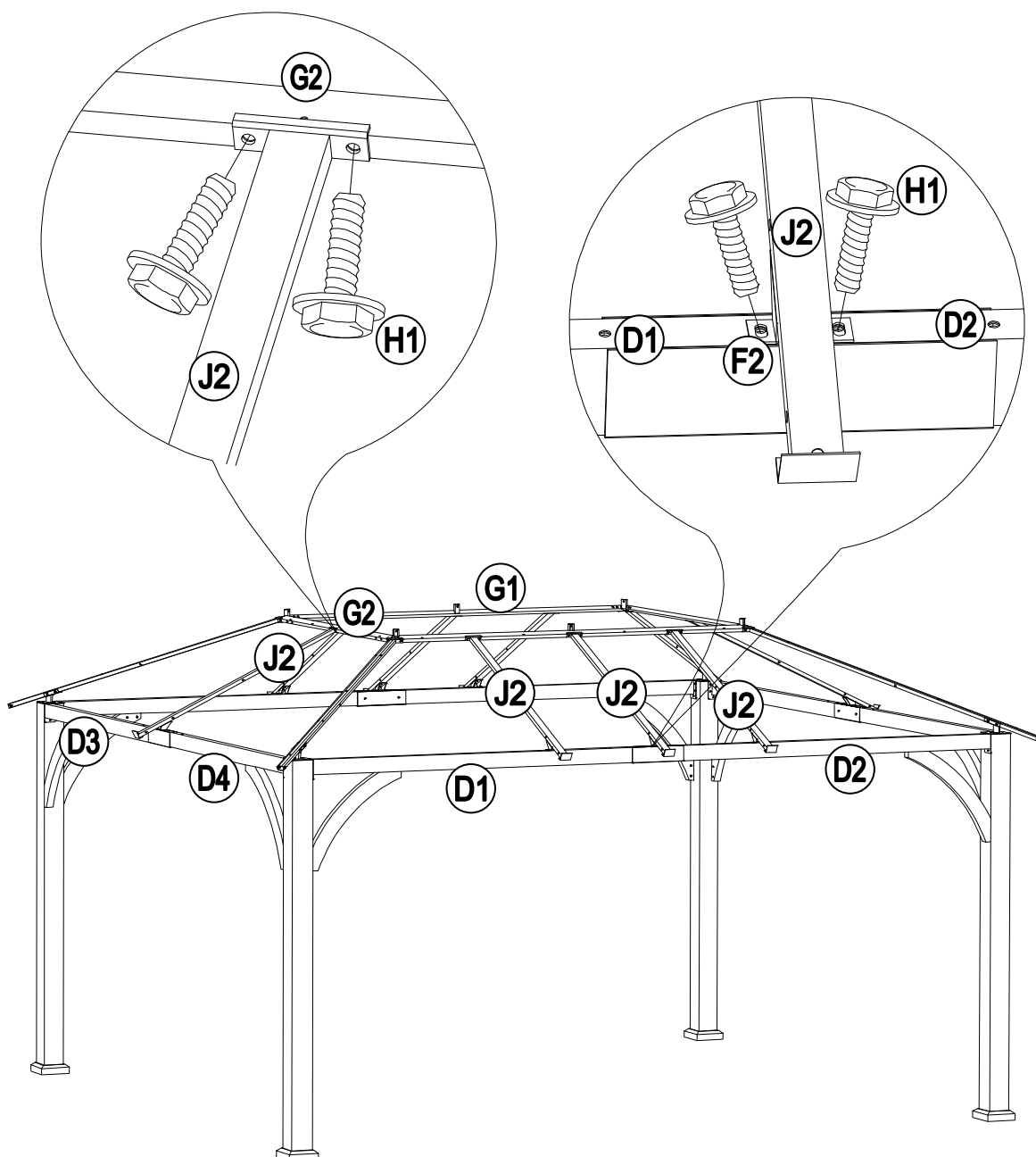
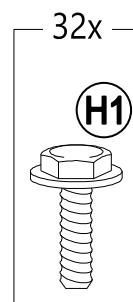

# 11

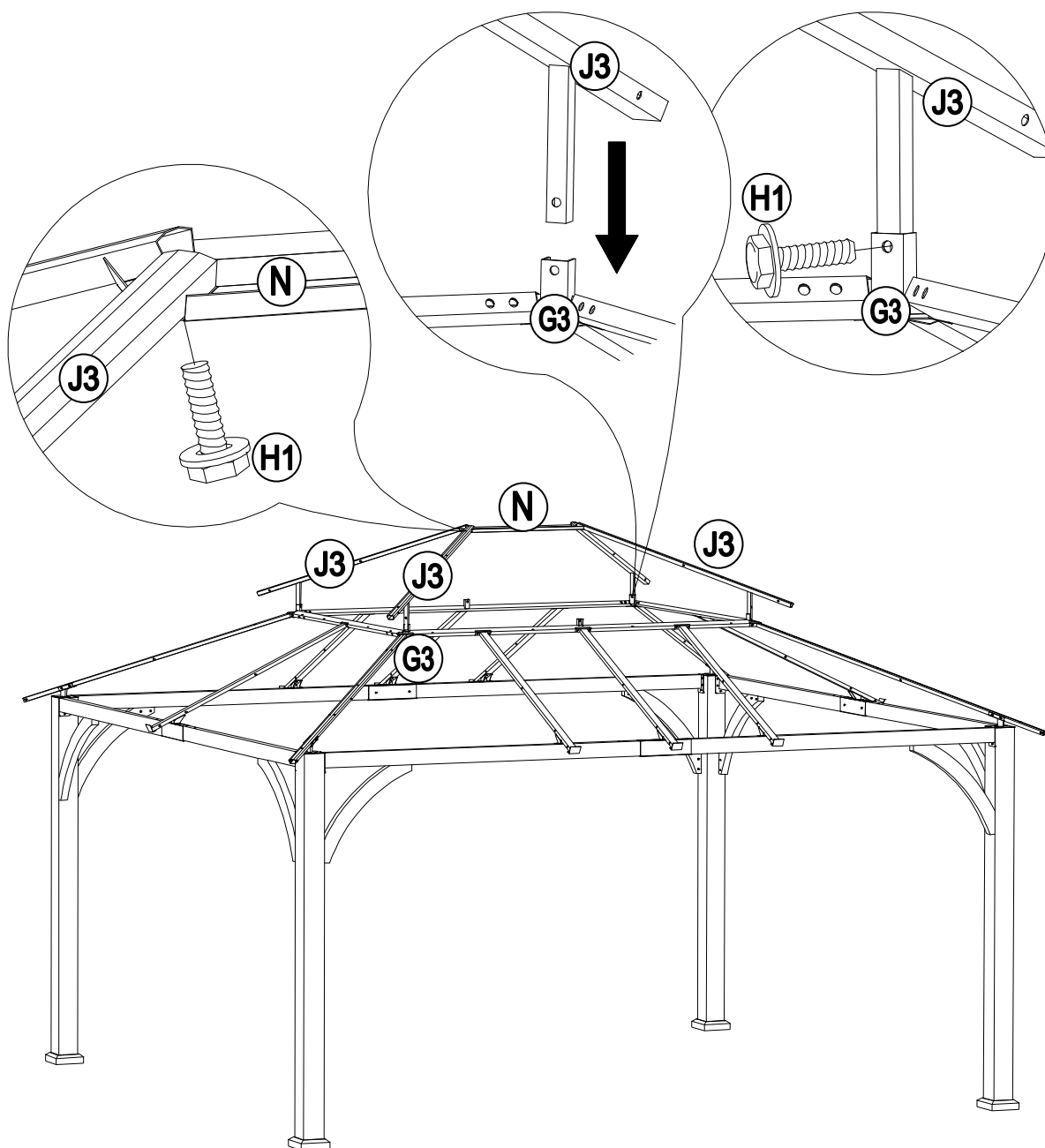
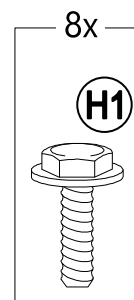
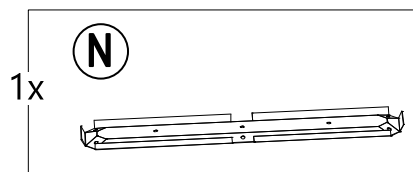
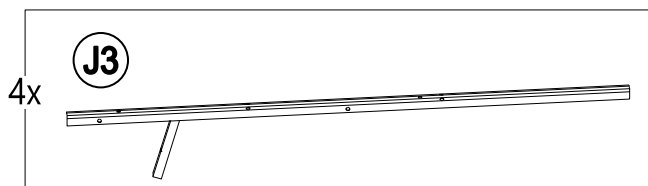

# 12

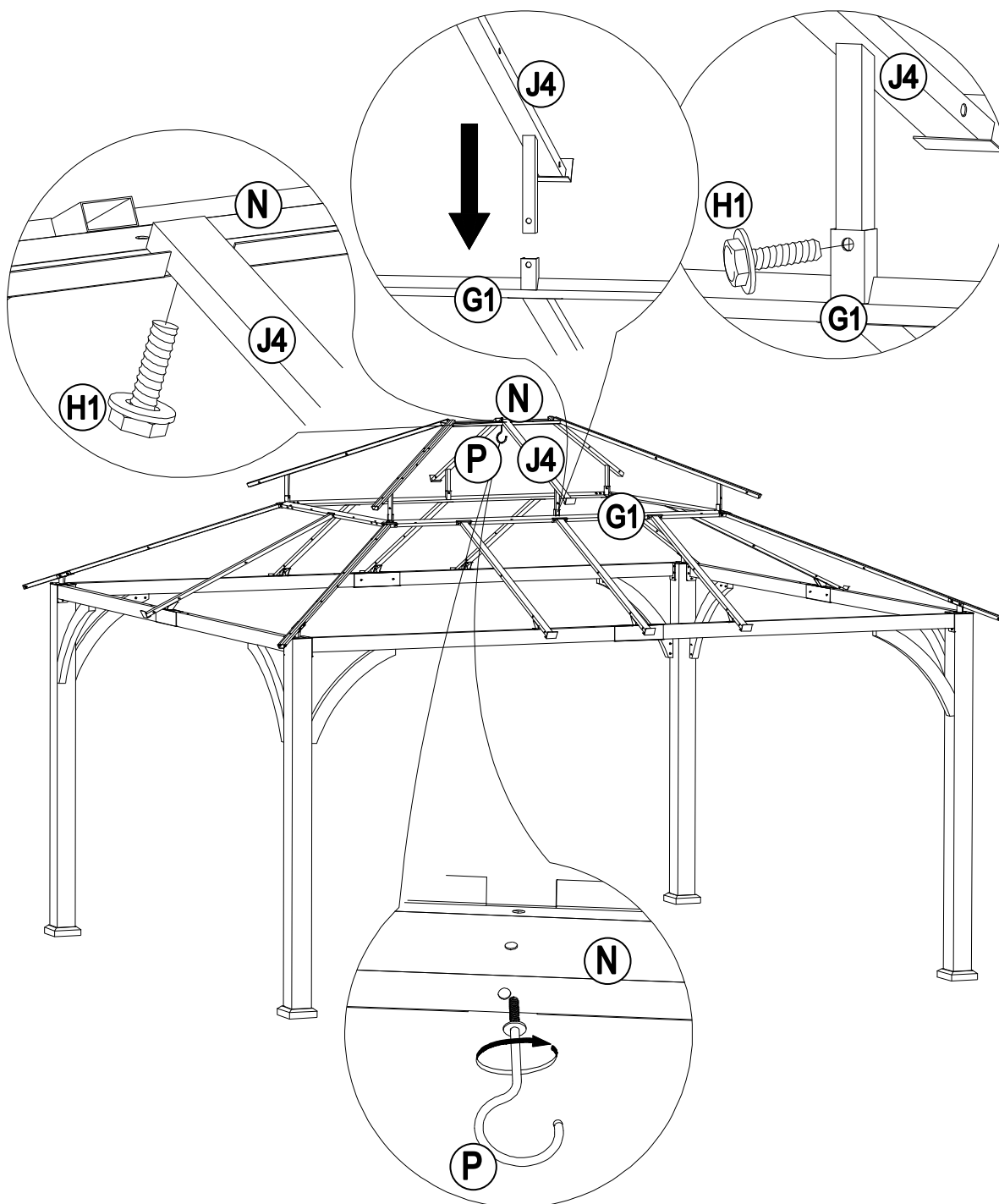
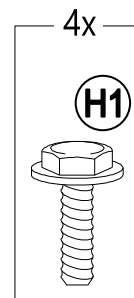
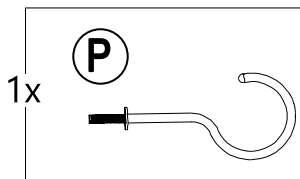
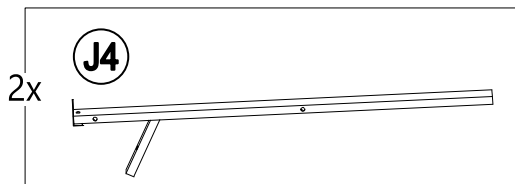

# 13

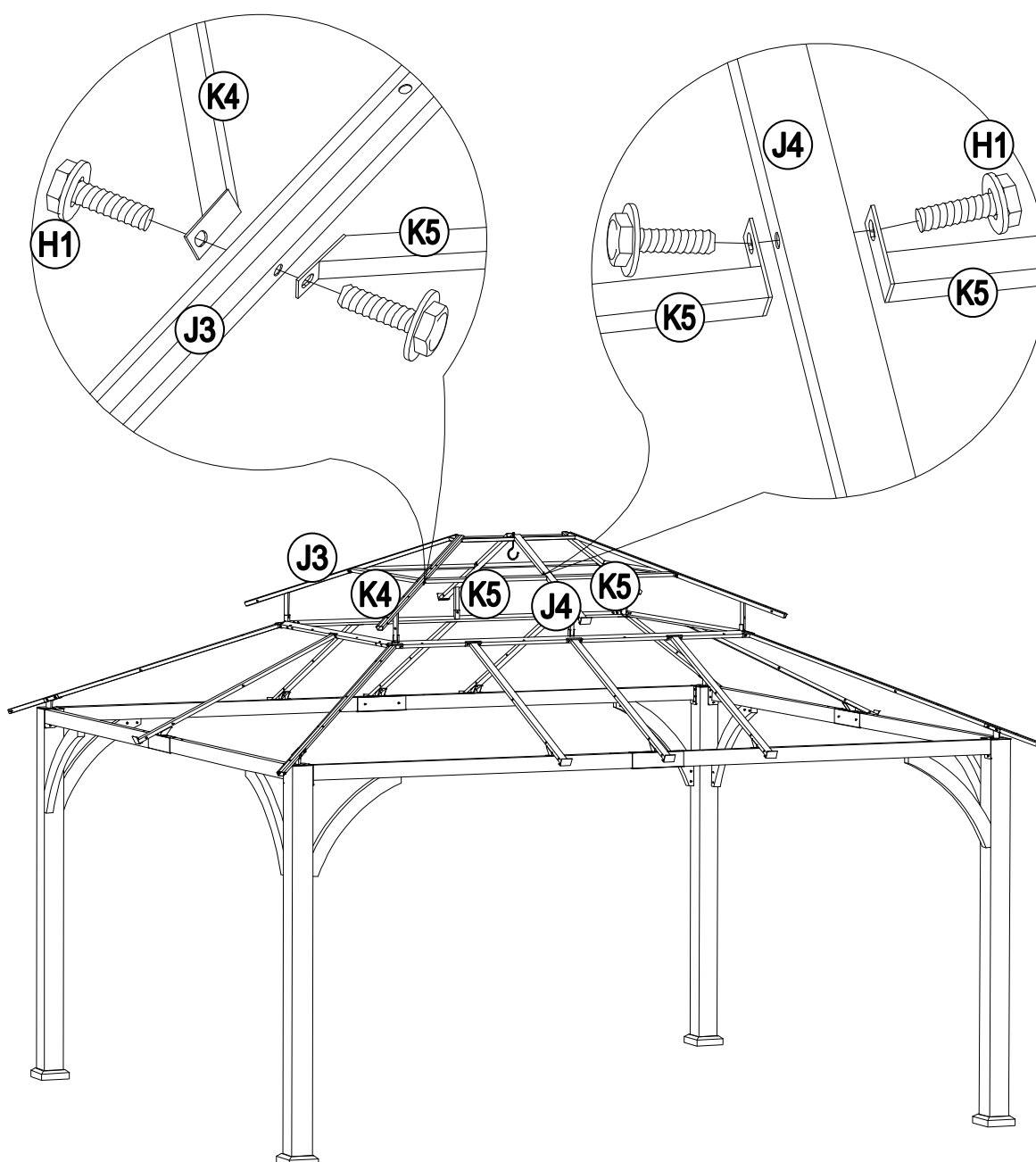
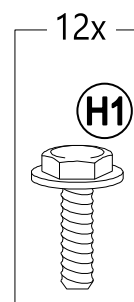
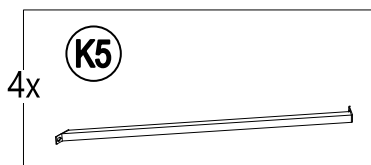
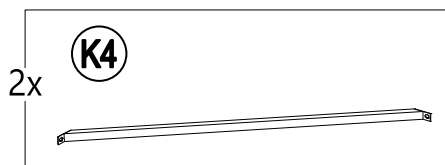

# 14

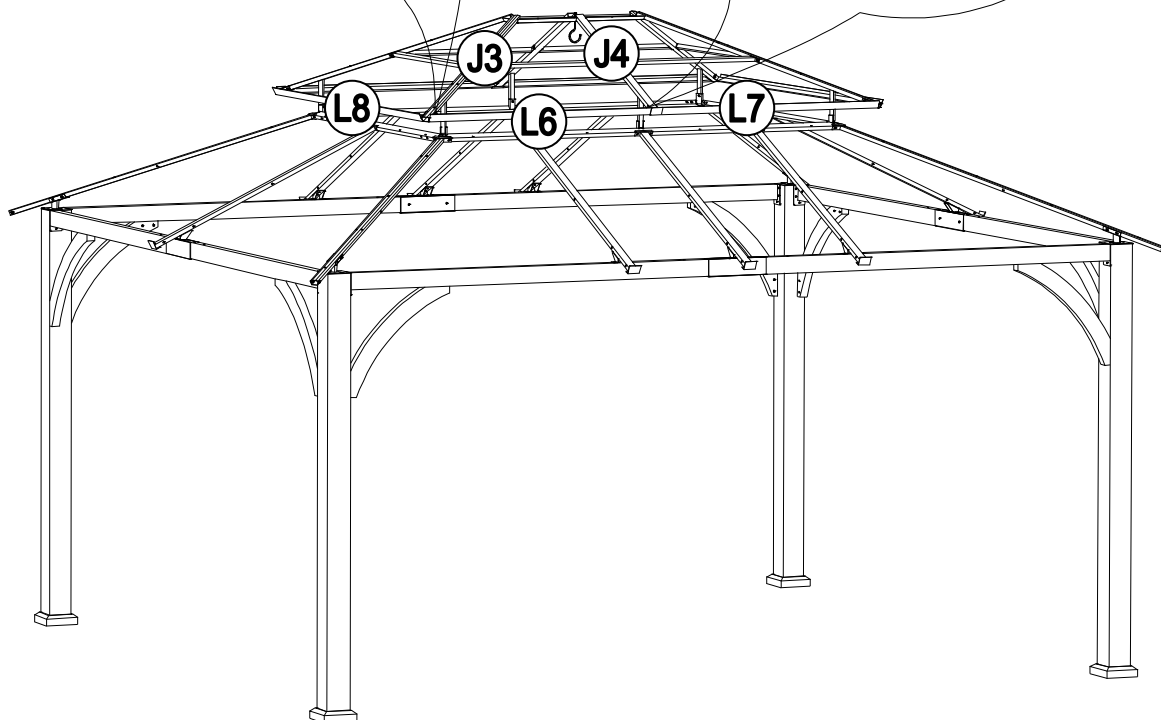
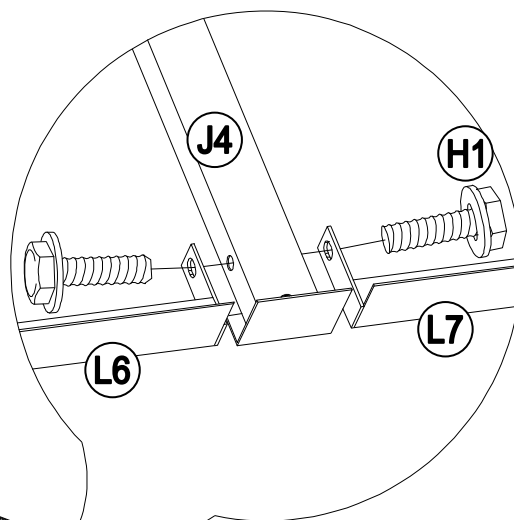
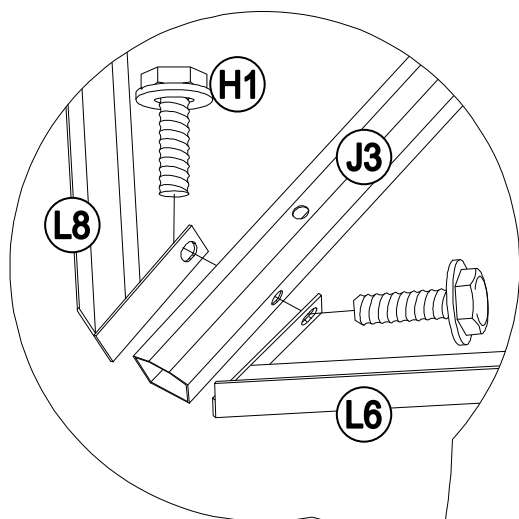
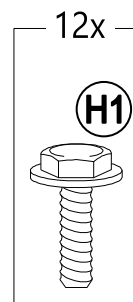
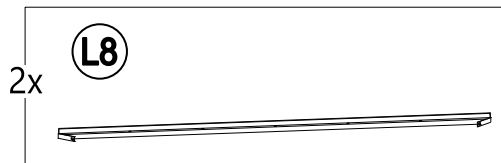
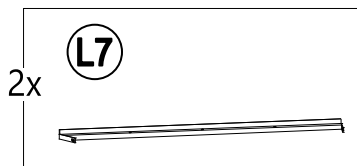
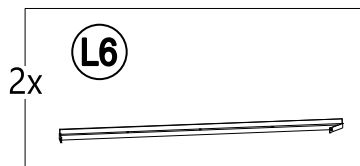

# 15

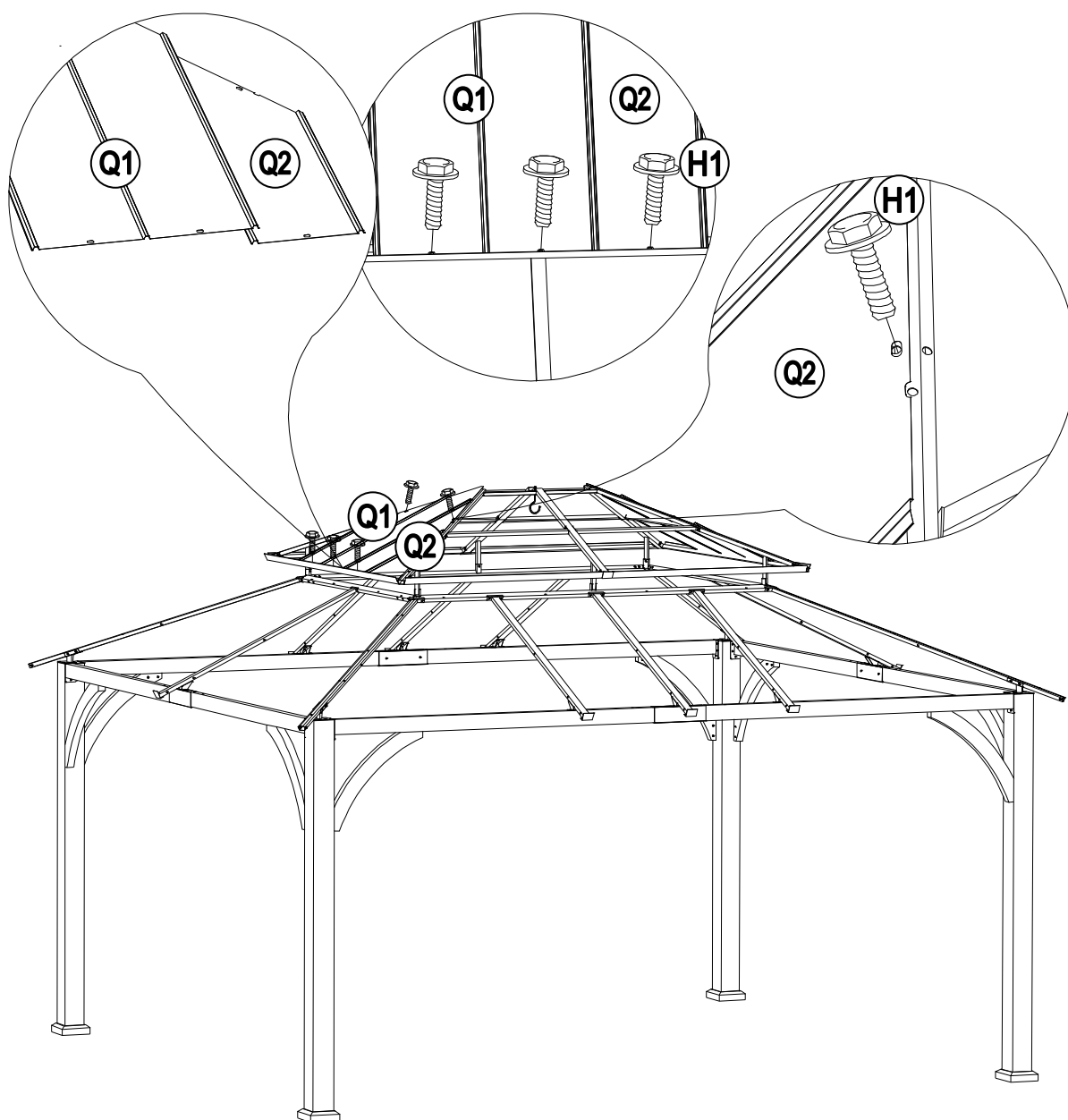
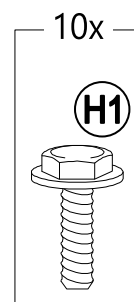
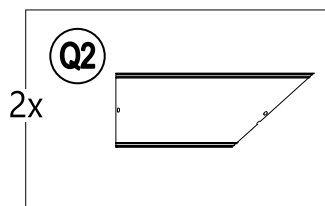
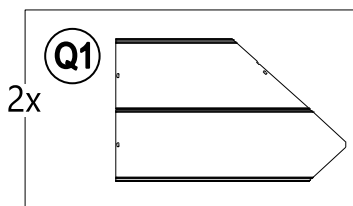

16

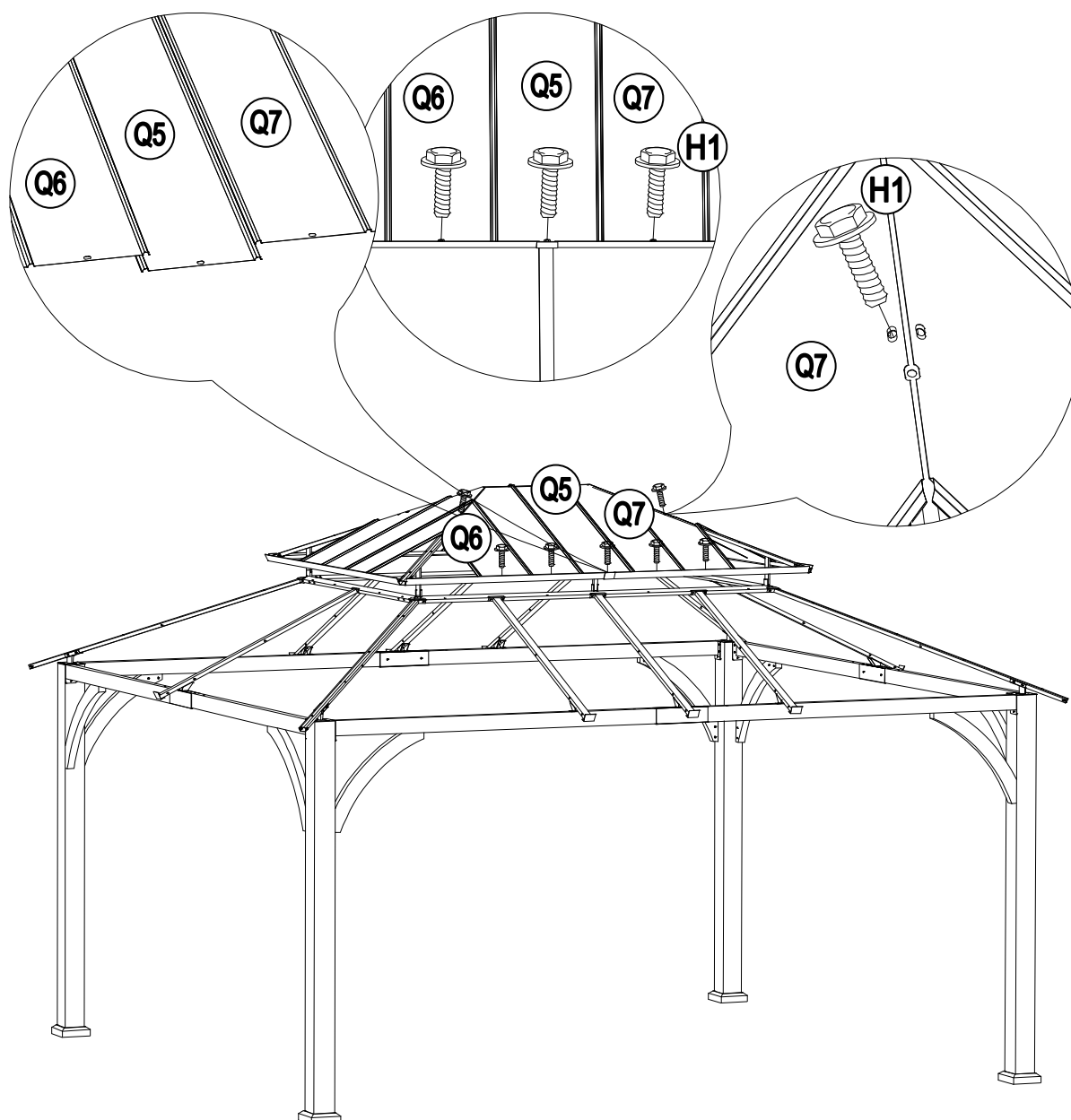
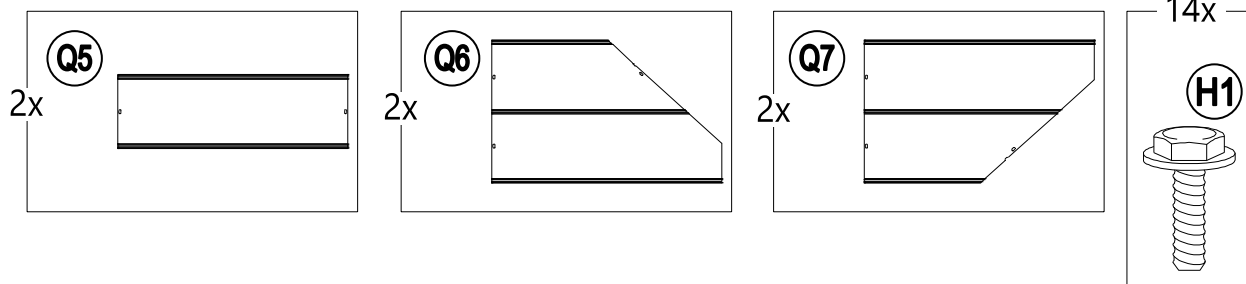

# 17

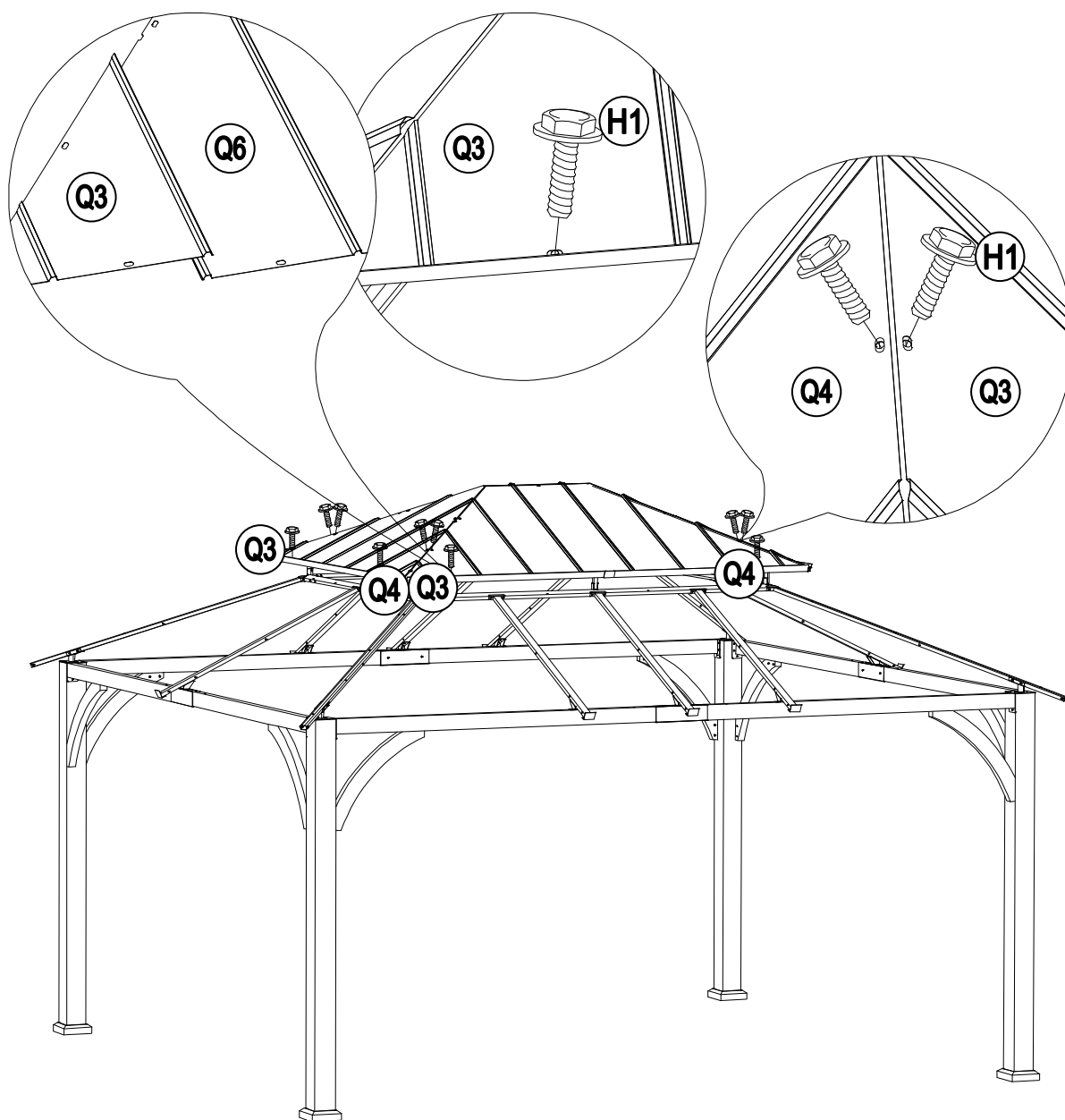
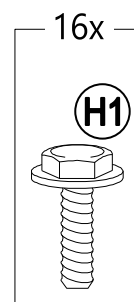
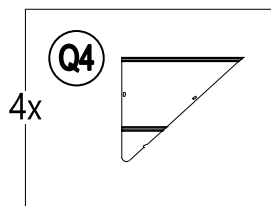
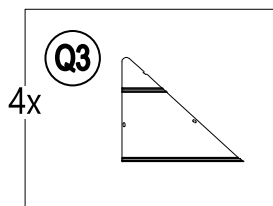



# 18

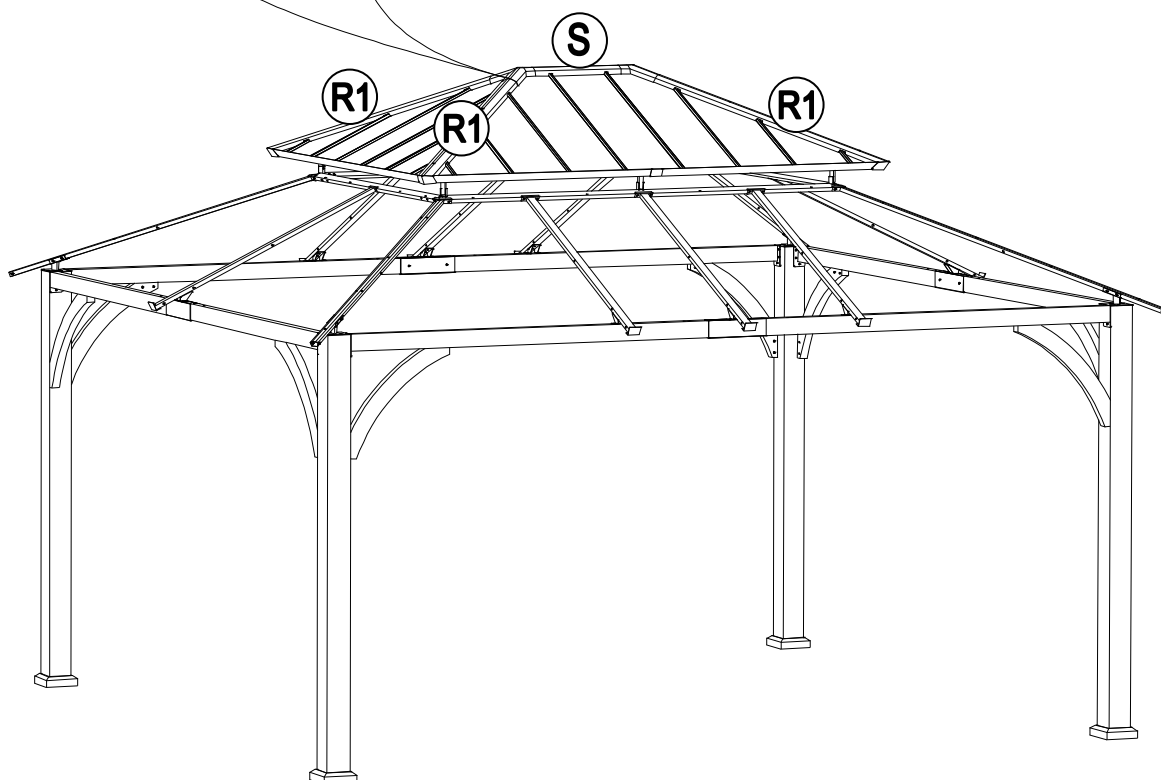
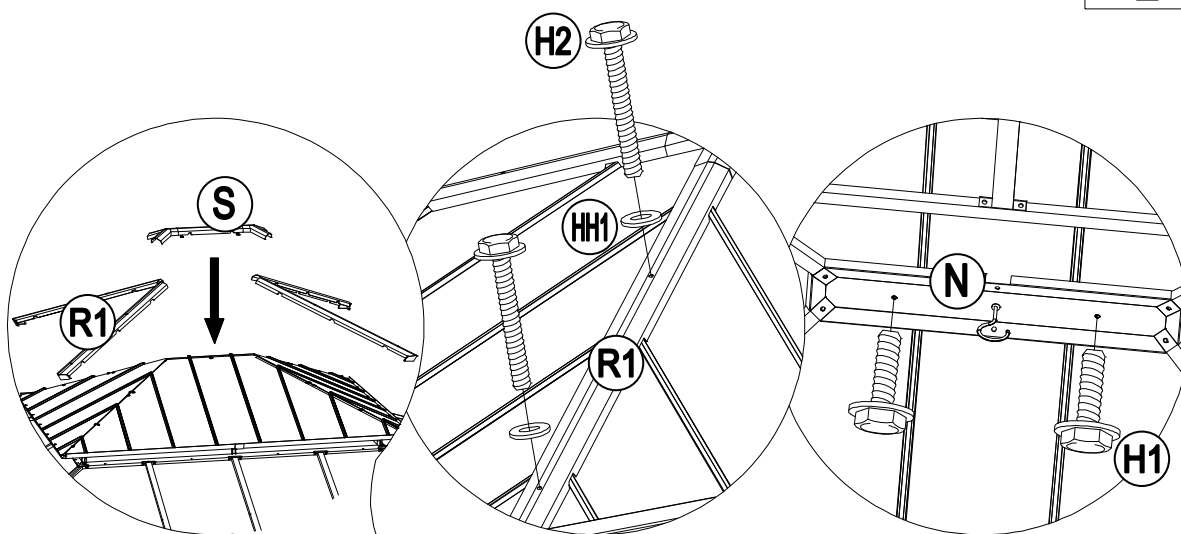
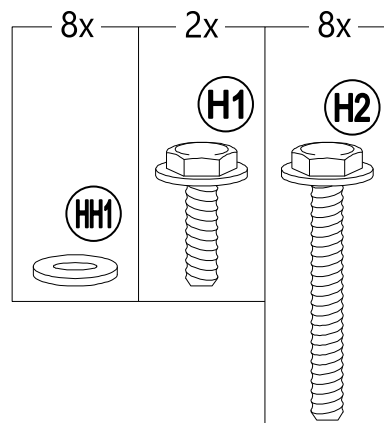
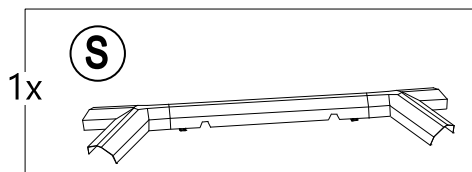
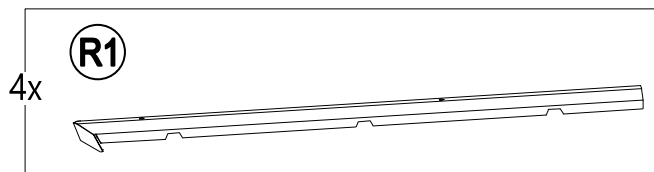

# 19

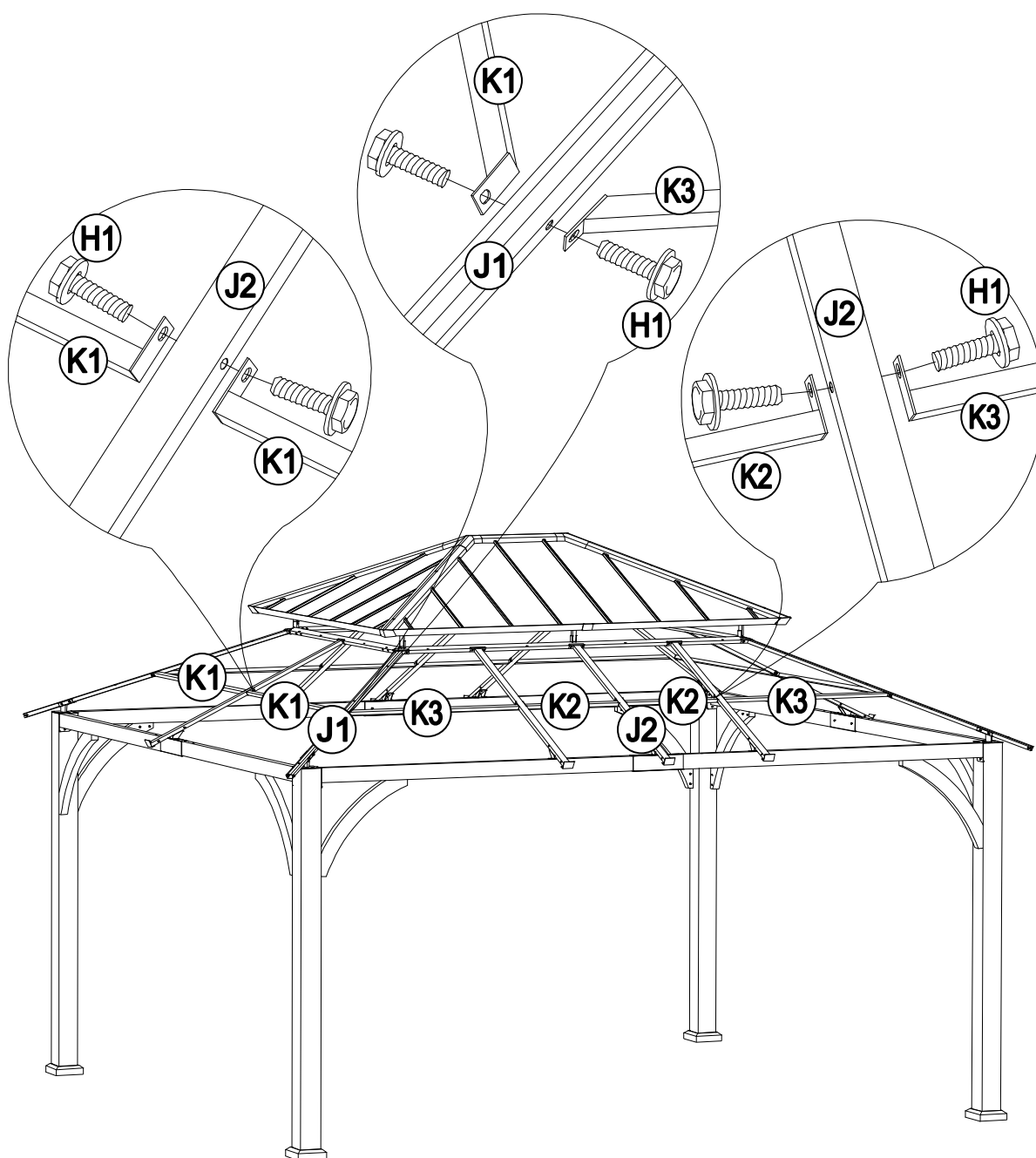
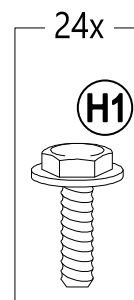
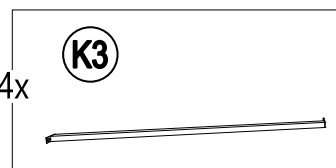
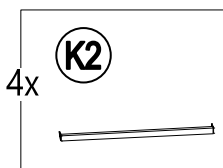

# 20

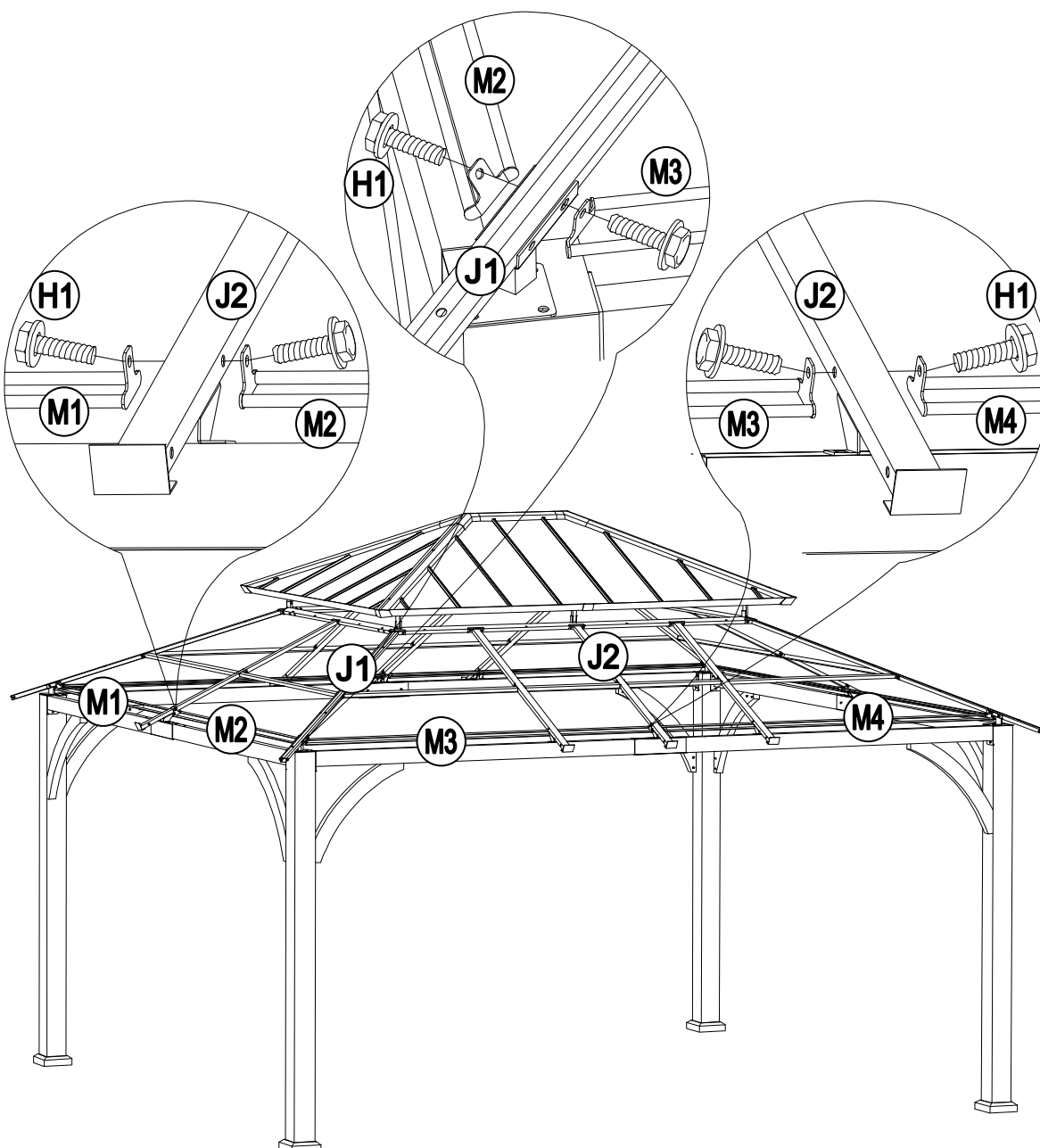
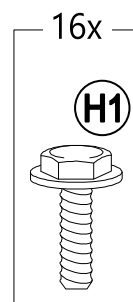
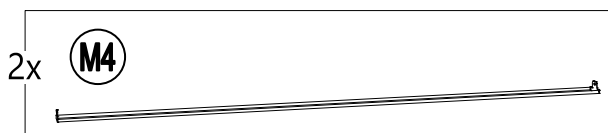
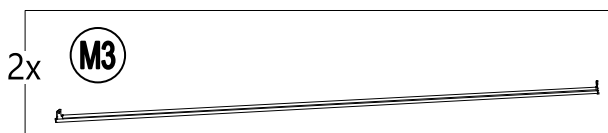
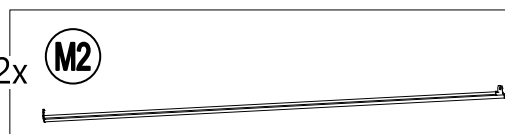
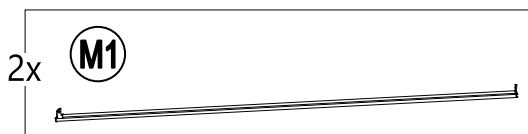

# 21

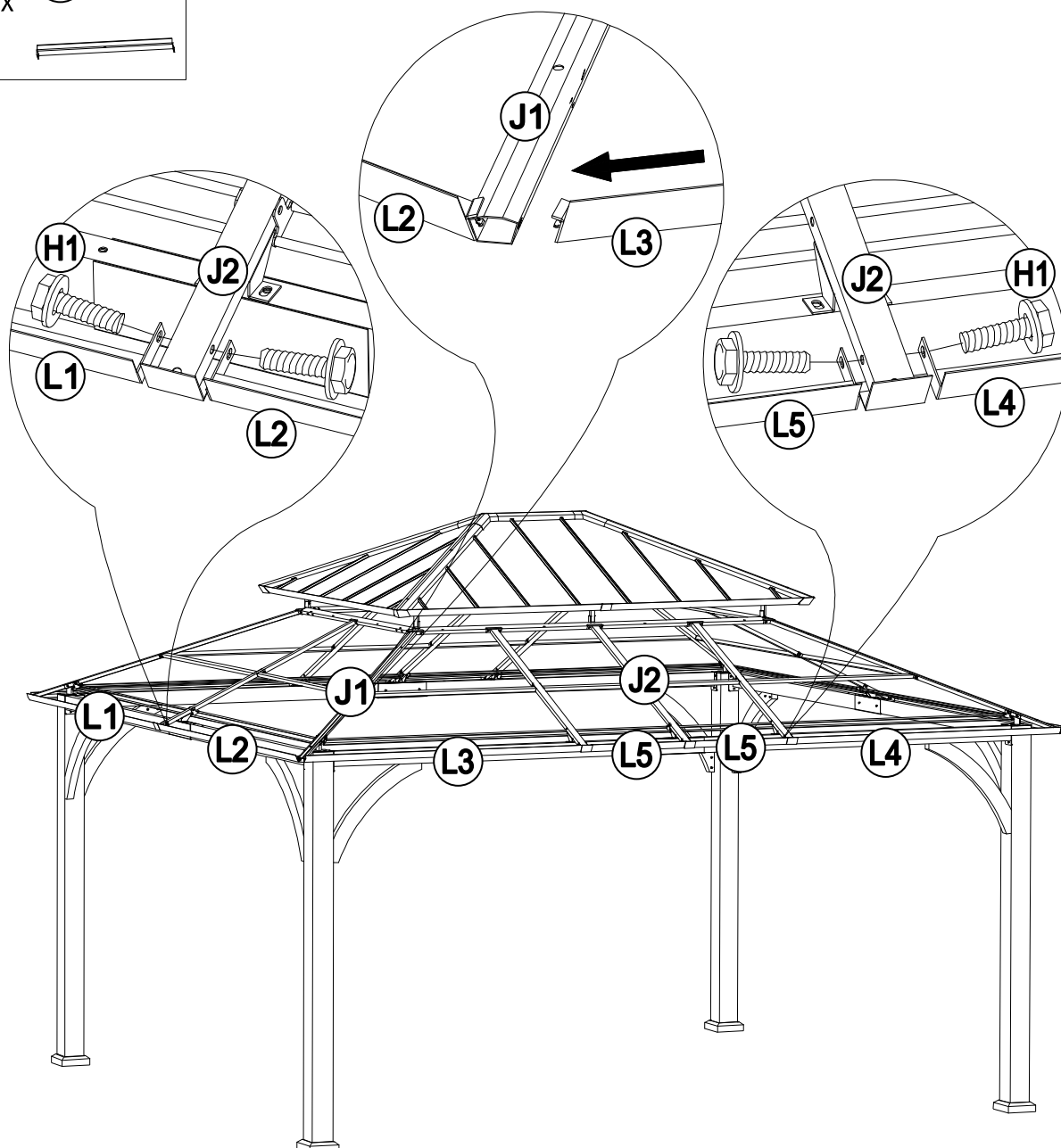
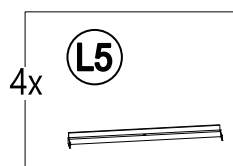
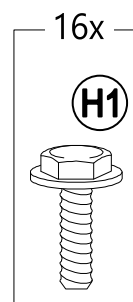
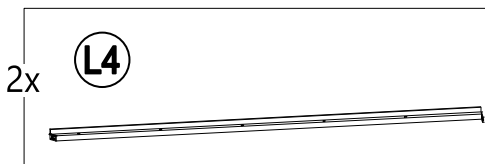
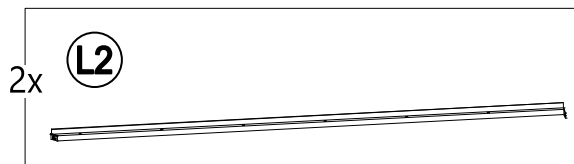
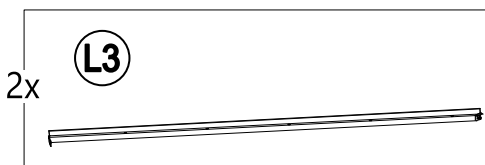
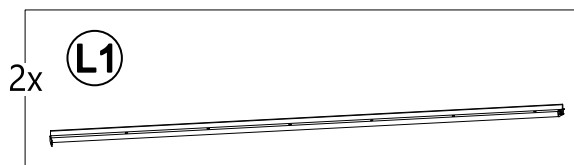

# 22

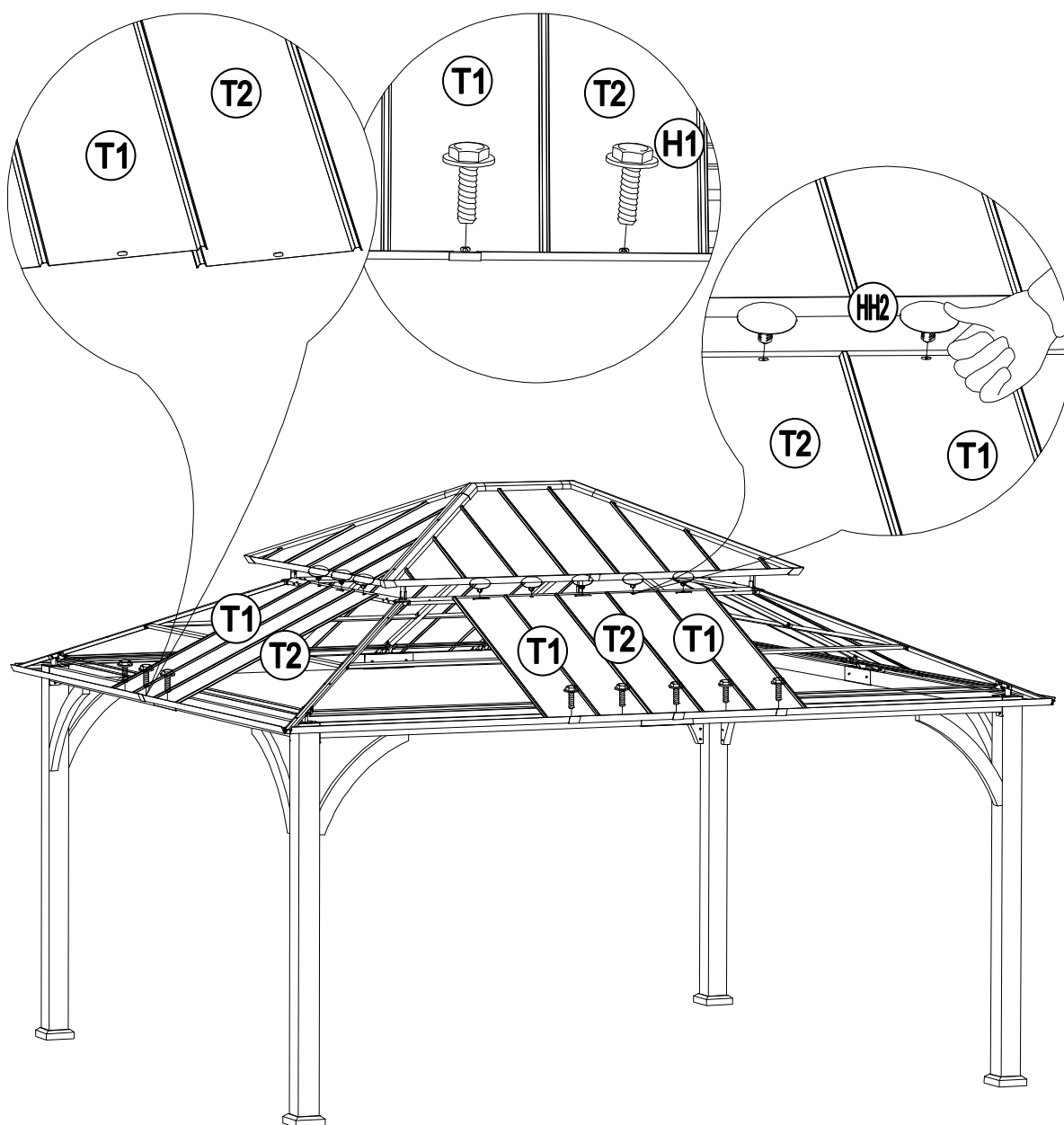
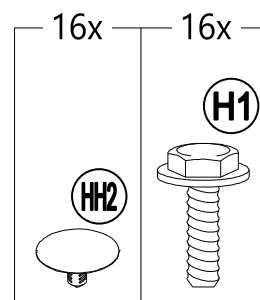
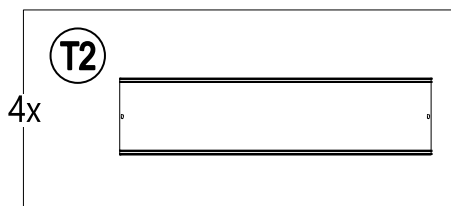
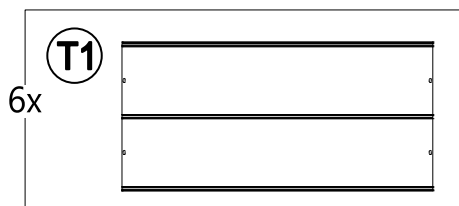

# 23

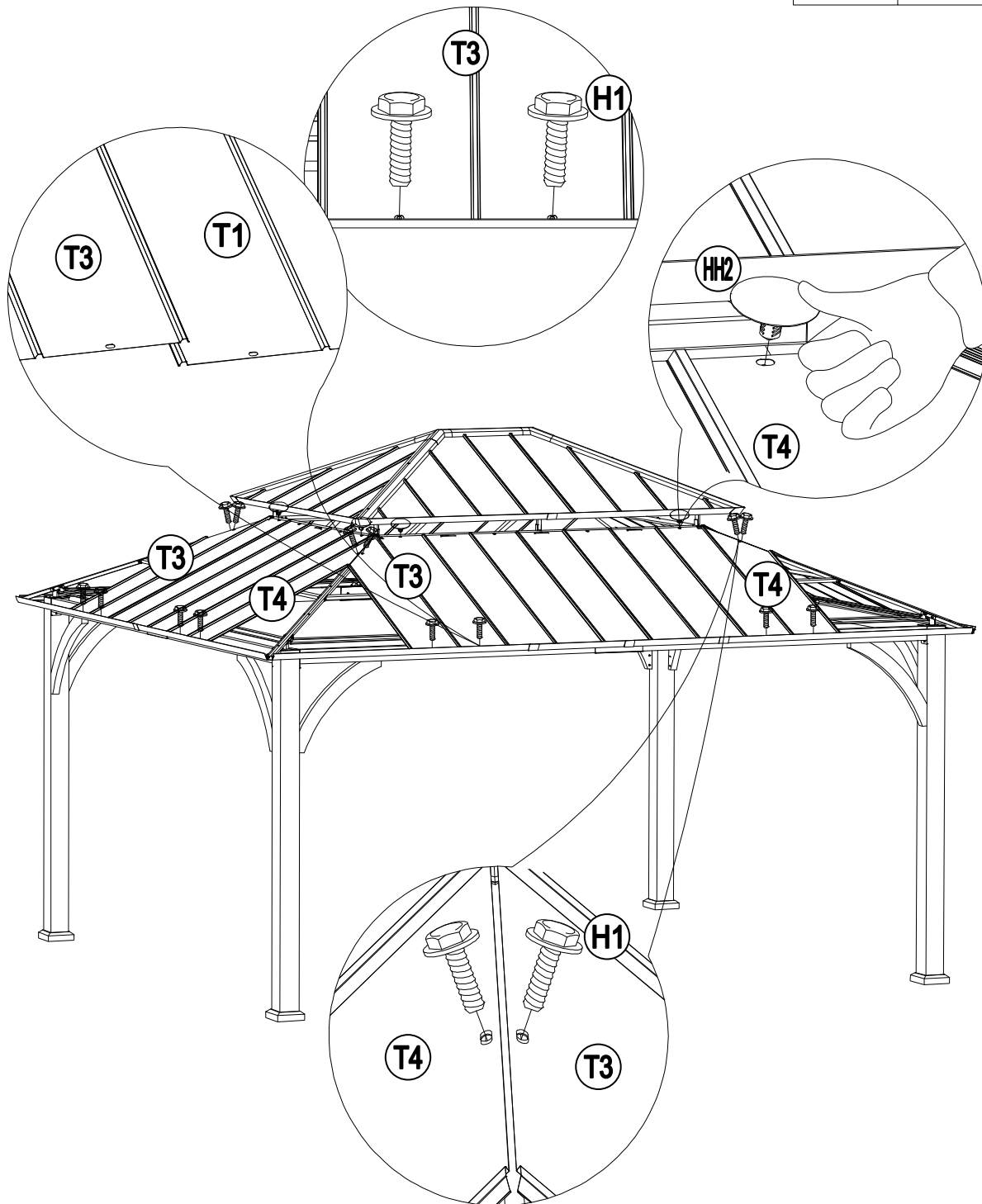
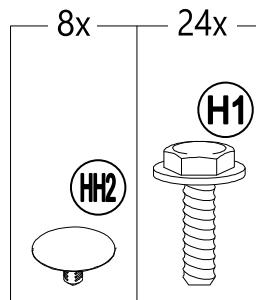
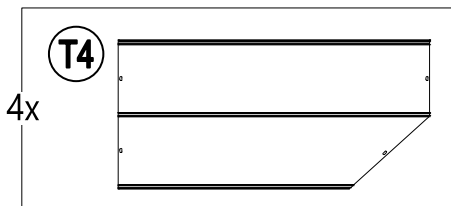
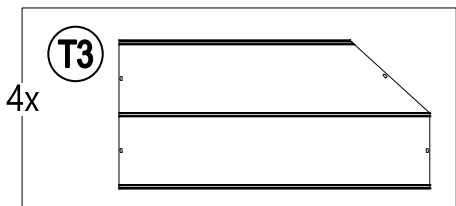

# 24

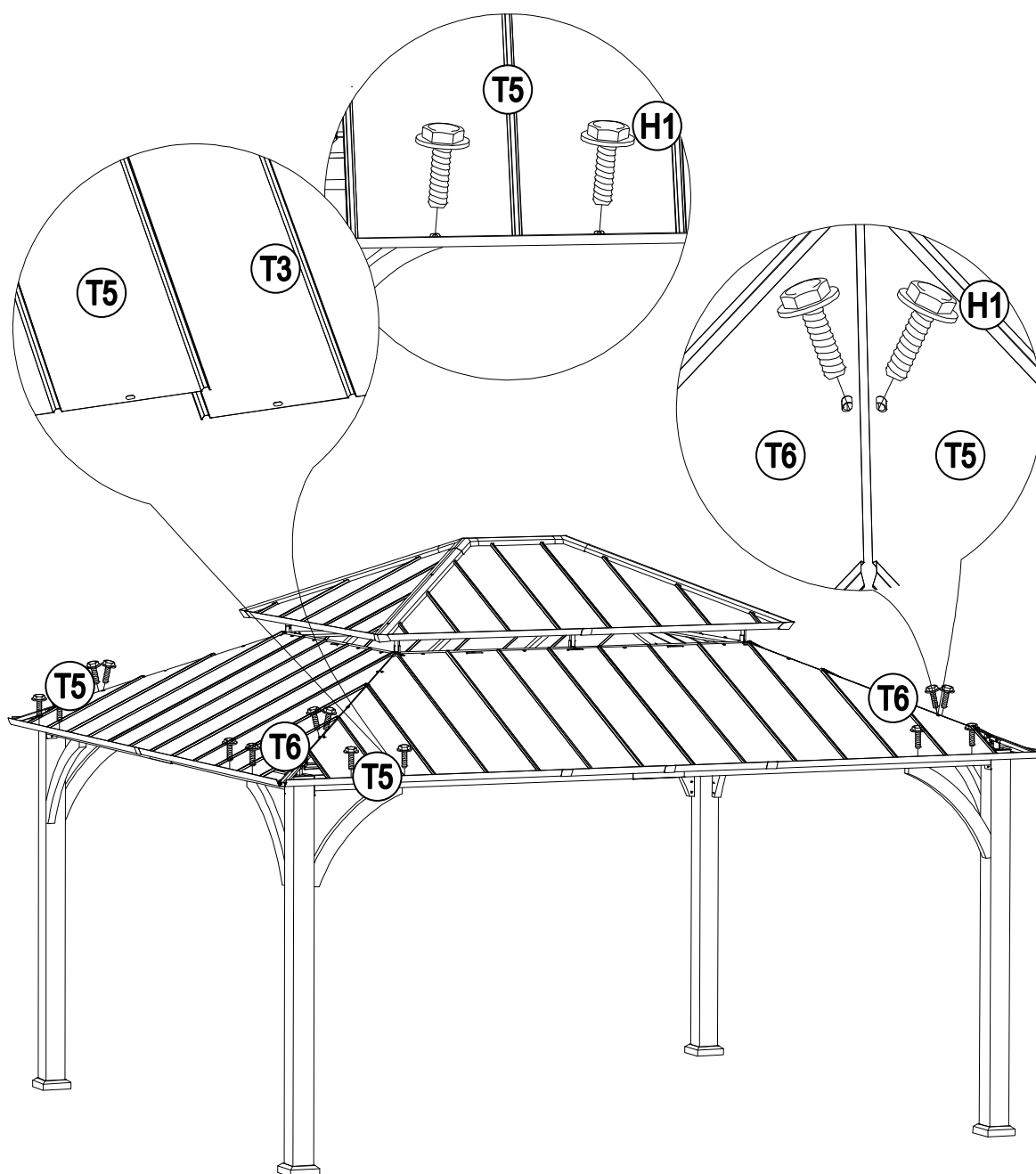
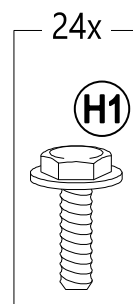
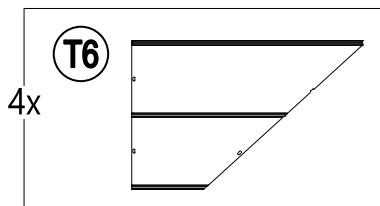
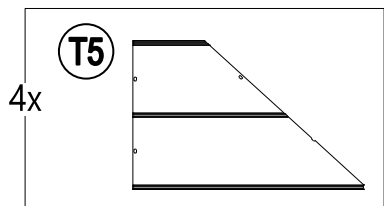

# 25

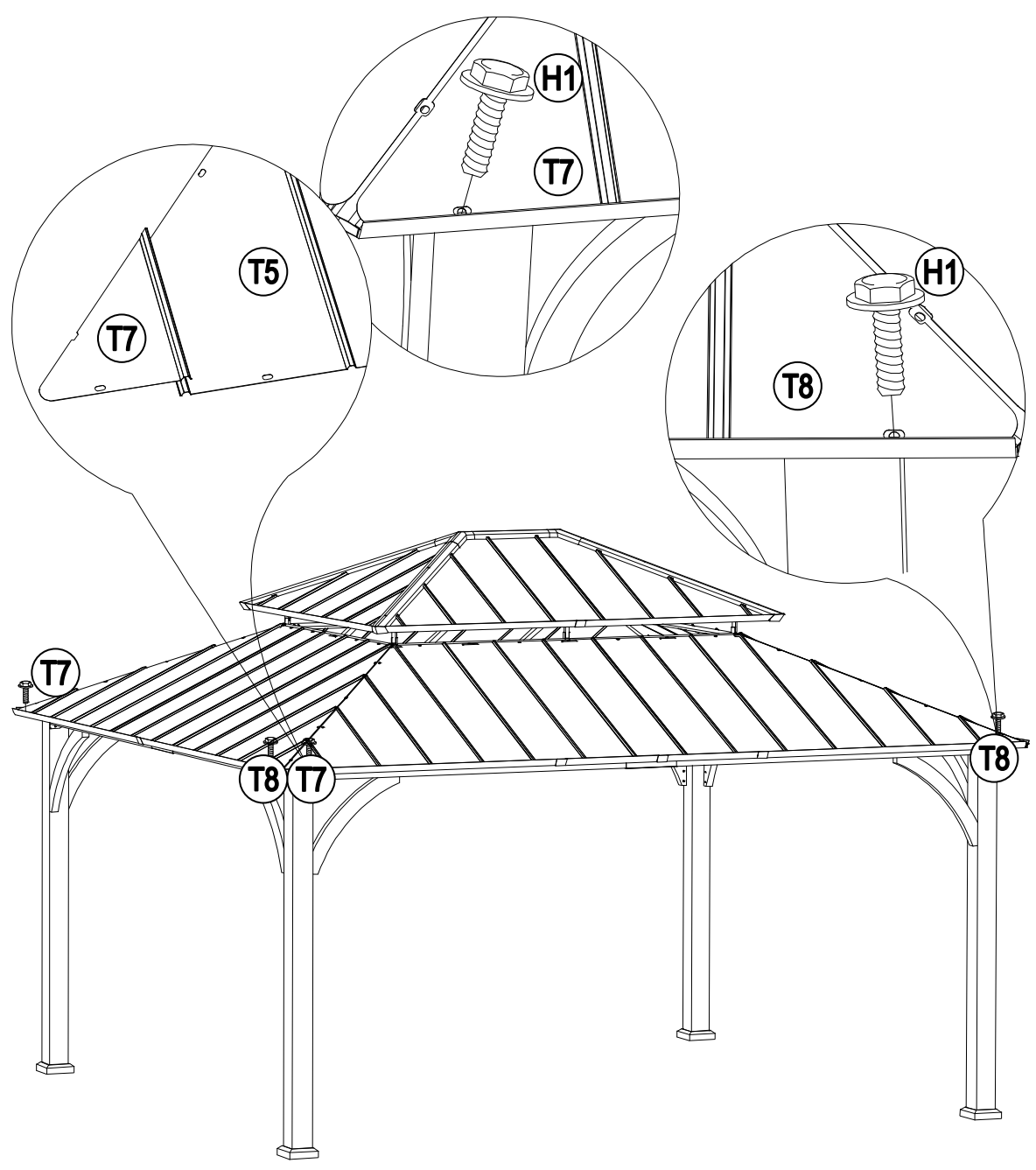
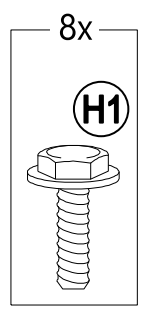
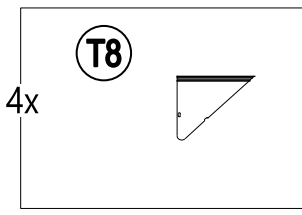
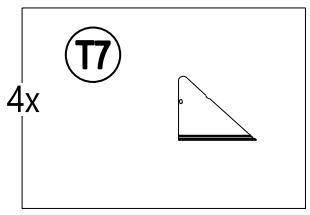



# 26

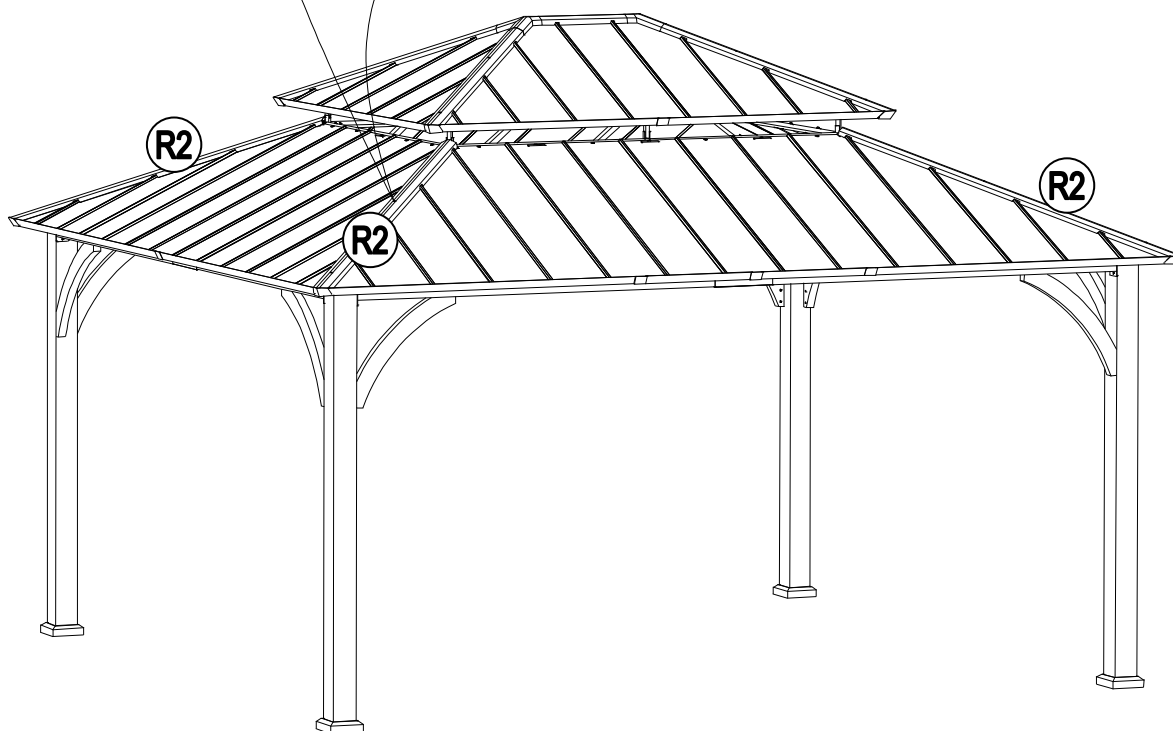
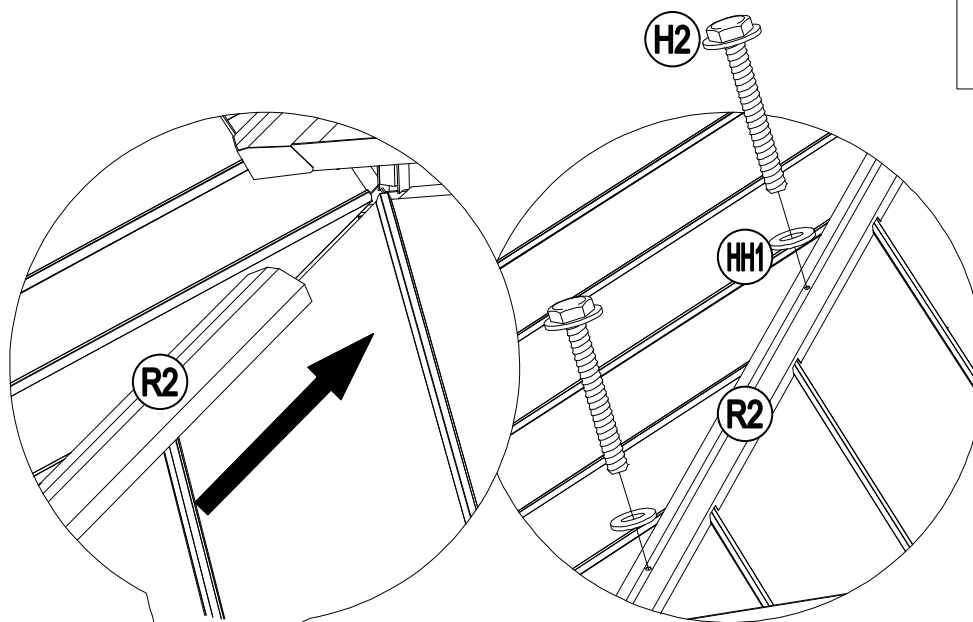
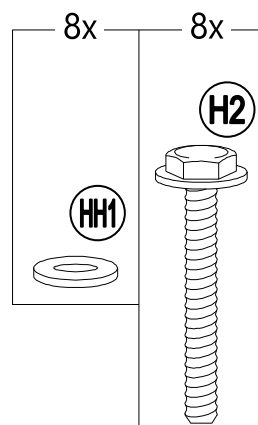
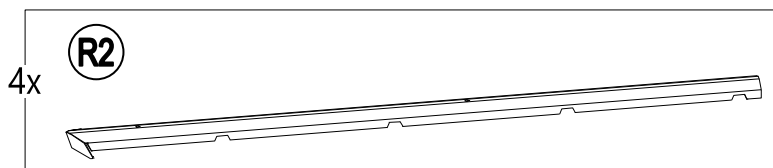

# 27

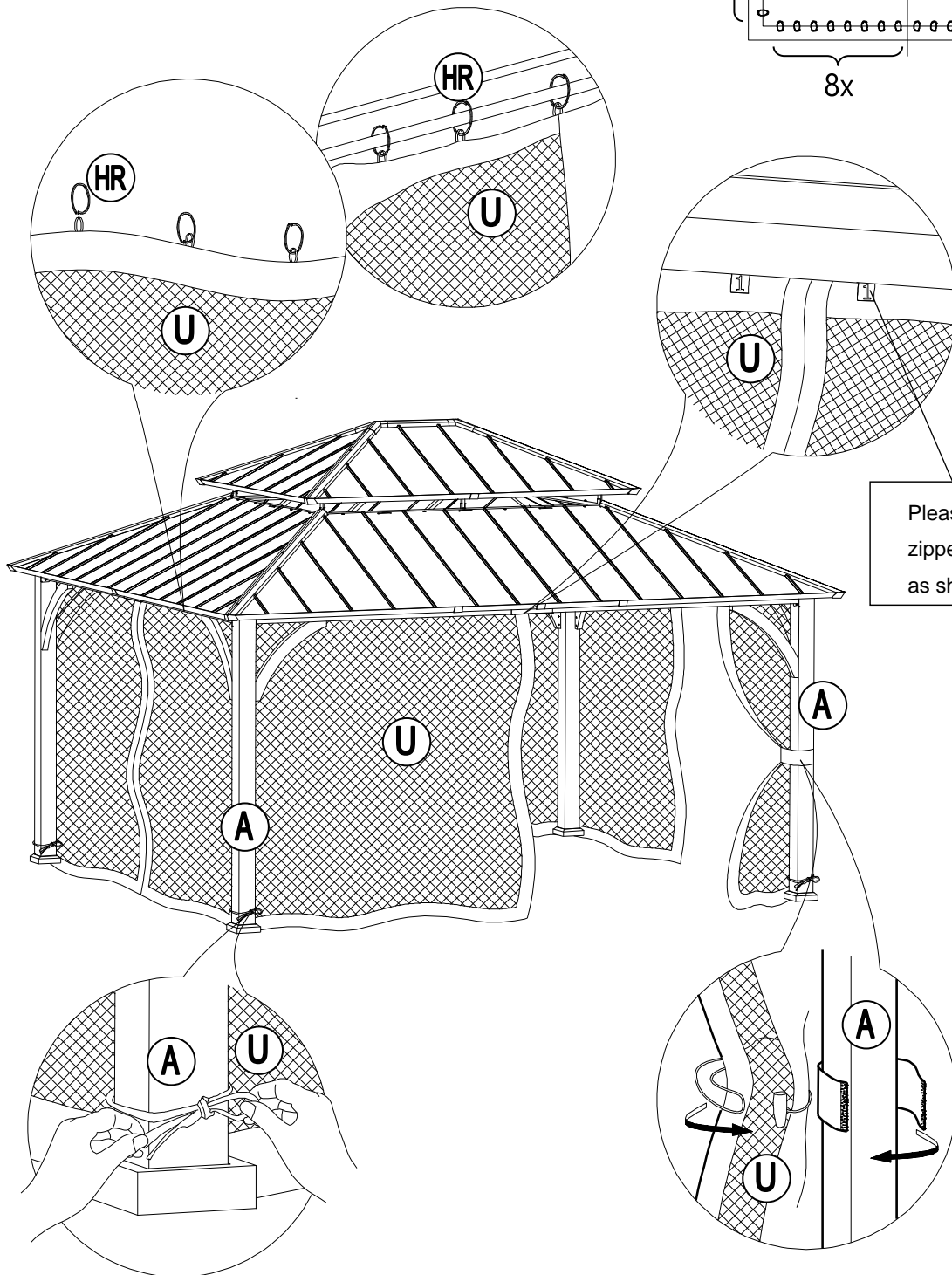
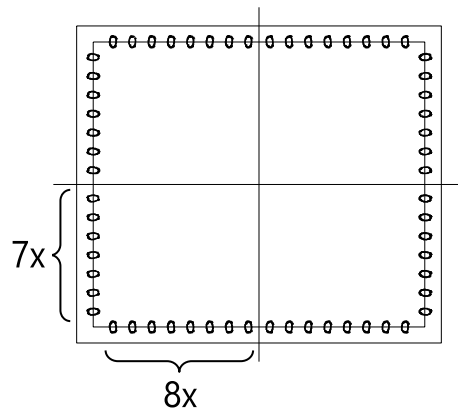
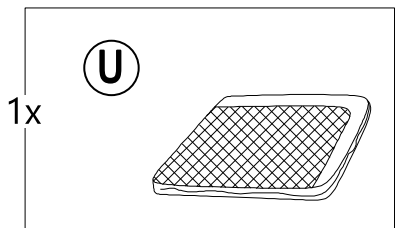

Please do the matching of zippers for different panels as showing the picture.

# 28

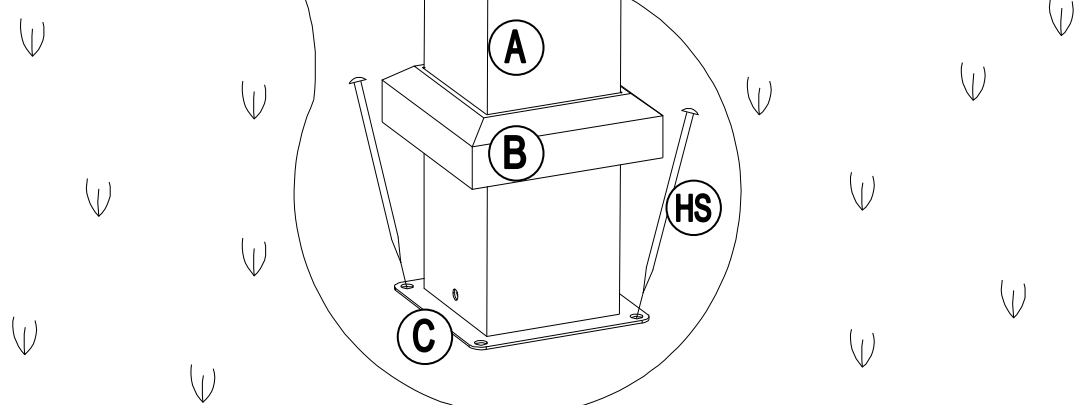
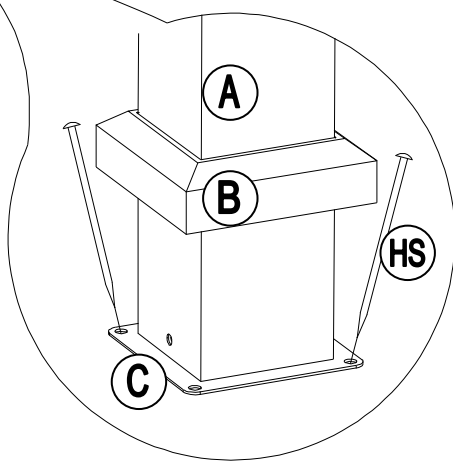
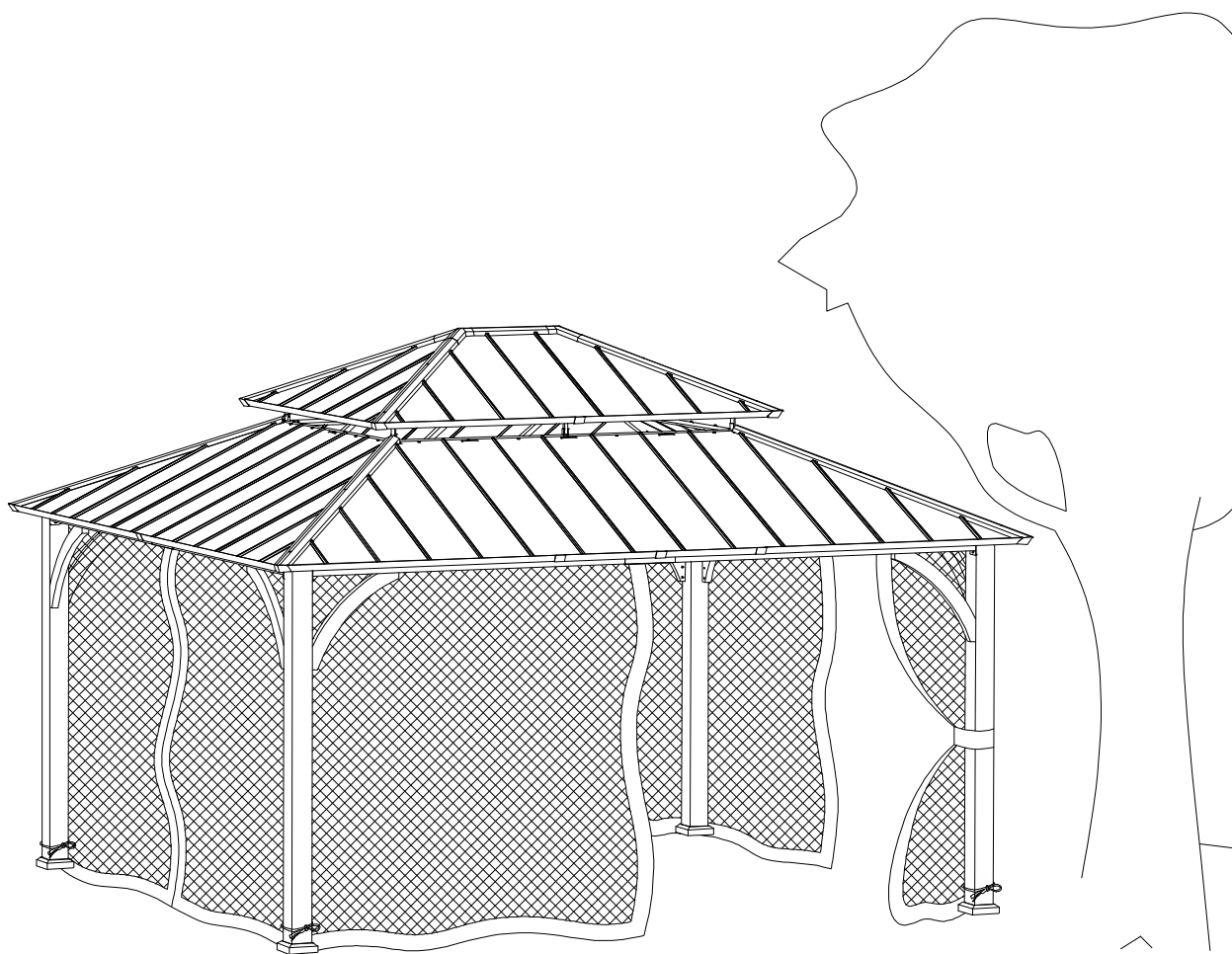

## Cleaning and Maintenance

### Caution!

- Check all screws and nuts periodically for tightness, fastening them again as required.
- Disassemble the gazebo in the reverse order of the assembly steps. Always disassemble the gazebo completely. A partially disassembled gazebo is not stable enough to resist wind and bad weather, and therefore can be damaged and/or cause damage.
- Clean the gazebo with mild soap and water. Rinse thoroughly, and wait until the product is dry before reassembling it.
- Remove all excess snow from the roof.
- Do not use bleach, acid, or other abrasive cleaners on the frame parts.
- Steel components for this gazebo are treated with rust inhibiting paint. However, due to the nature of steel, surface oxidation (rusting) will occur if these protective coatings are scratched. This is not a defect and thus not covered by the warranty, To minimize this condition, it is recommended to use care when assembling and handling the product to prevent scratching the paint. Should any scratching or damage occur, it is recommended to cover the scratch immediately with rust inhibiting paint (not included) . Surface rust can also be easily removed with a very light application of regular cooking oil or WD-40. If surface oxidation (rusting) occurs and if no measure is taken to prevent this, the oxidation may start dripping onto deck or patio and caused damaging stains, which may be difficult to remove. This can be prevented if the above-mentioned measures are taken to keep the product from oxidizing.
- Keep instruction manual for future reference.
- Keep the original packaging to store the gazebo.